

# Burst-Mode PON Controller With Integrated Monitoring

**DS1863**

## General Description

The DS1863 controls and monitors all the burst-mode transmitter and video receiver biasing functions for a passive optical network (PON) transceiver. It has an APC loop with tracking-error compensation that provides the reference for the laser-driver's bias current, and a temperature indexed lookup table (LUT) that controls the modulation current. It continually monitors for high output current, high bias current, and low and high transmit power with its internal fast comparators to ensure that laser shutdown for eye safety requirements are met without adding external components. Five ADC channels monitor VCC, internal temperature, and three external monitor inputs (MON1–3) that can be used to meet transmitter and receive monitoring requirements.

## Applications

BPON, GPON and GEAPON, Burst-Mode Transmitters  
Laser Control and Monitoring  
Broadband Local Access

## Features

- ◆ Meets BPON, GPON, and GEAPON Timing Requirements for Burst-Mode Transceivers
- ◆ Bias Current Control provided by APC Loop with Tracking Error Compensation
- ◆ Modulation Current is Controlled by a Temperature-Indexed Lookup Table
- ◆ Supports 0dB, -3dB, -6dB Power Leveling Settings with no Additional Calibration
- ◆ Internal Direct-to-Digital Temperature Sensor
- ◆ Five Analog Monitor Channels: Temperature, VCC, MON1, MON2, and MON3
- ◆ Comprehensive Fault Management System with Maskable Laser Shutdown Capability
- ◆ Two-Level Password Access to Protect Calibration Data
- ◆ 120 Bytes of Password 1 (PW1) Protected Nonvolatile Memory
- ◆ 128 Bytes of Password 2 (PW2) Protected Nonvolatile Memory
- ◆ I<sup>2</sup>C-Compatible Interface for Calibration and Monitoring
- ◆ Operating Voltage: 2.85V to 5.5V
- ◆ Operating Temperature: -40°C to +95°C
- ◆ 16-Pin Lead-Free TSSOP Package

## Pin Configuration

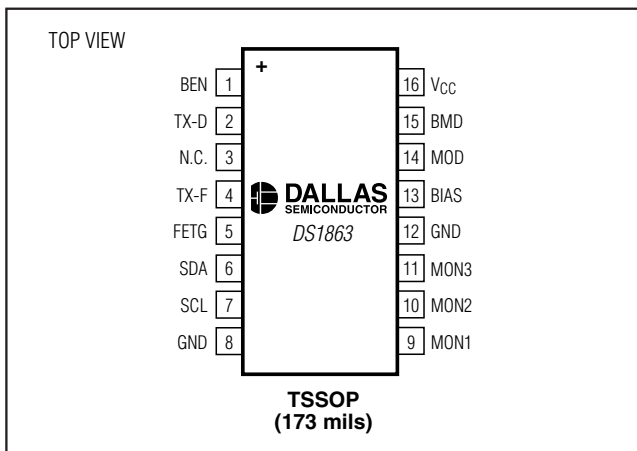

## Ordering Information

PART	TEMP RANGE	PIN-PACKAGE
DS1863E+	-40°C to +95°C	16 TSSOP
DS1863E+T&R	-40°C to +95°C	16 TSSOP

+Denotes lead-free package.  
T&R denotes tape-and-reel.

# Burst-Mode PON Controller With Integrated Monitoring

## ABSOLUTE MAXIMUM RATINGS

Voltage on V<sub>CC</sub>, SDA and SCL Pin Relative to Ground .....-0.5V to 6V  
Voltage on BEN, TX-D, TX-F, MON1–MON3, BMD Relative to Ground .....-0.5V to V<sub>CC</sub> + 0.5V (subject to not exceeding +6V)

Operating Temperature Range .....-40°C to +95°C  
Programming Temperature Range .....0°C to +70°C  
Storage Temperature Range .....-55°C to +125°C  
Soldering Temperature .....See J-STD-020 specification

*Stresses beyond those listed under "Absolute Maximum Ratings" may cause permanent damage to the device. These are stress ratings only, and functional operation of the device at these or any other conditions beyond those indicated in the operational sections of the specifications is not implied. Exposure to absolute maximum rating conditions for extended periods may affect device reliability.*

## RECOMMENDED OPERATING CONDITIONS

(T<sub>A</sub> = -40°C to +95°C, unless otherwise noted.)

PARAMETER	SYMBOL	CONDITIONS	MIN	TYP	MAX	UNITS
Supply Voltage	V <sub>CC</sub>	(Note 1)	+2.85		5.5	V
High-Level Input Voltage (SDA, SCL, BEN)	V <sub>IH:1</sub>		0.7 x V <sub>CC</sub>		V <sub>CC</sub> + 0.3	V
Low-Level Input Voltage (SDA, SCL, BEN)	V <sub>IL:1</sub>		-0.3		0.3 x V <sub>CC</sub>	V
High-Level Input Voltage (TX-D)	V <sub>IH:2</sub>		2.0		V <sub>CC</sub> + 0.3	V
Low-Level Input Voltage (TX-D)	V <sub>IL:2</sub>		-0.3		0.8	V

## ELECTRICAL CHARACTERISTICS

(V<sub>CC</sub> = +2.85V to +5.5V; T<sub>A</sub> = -40°C to +95°C, unless otherwise noted.)

PARAMETER	SYMBOL	CONDITIONS	MIN	TYP	MAX	UNITS
Supply Current	I <sub>CC</sub>	(Notes 1, 2)		5	7	mA
Output Leakage (SDA, TX-F)	I <sub>LO</sub>				1	μA
Low-Level Output Voltage (SDA, TX-F, FETG)	V <sub>OL</sub>	I <sub>OL</sub> = 4mA			0.4	V
		I <sub>OL</sub> = 6mA			0.6	
High-Level Output Voltage (FETG)	V <sub>OH</sub>	I <sub>OH</sub> = 4mA (Note 2)	V <sub>CC</sub> - 0.4			V
FETG Before Recall		(Note 3)		10	100	nA
Input Leakage Current (SCL, BEN, TX-D)	I <sub>LI:1</sub>				1	μA
Digital Power-On Reset	POD		1.0		2.2	V
Analog Power-On Reset	POA		2.1		2.75	V

# Burst-Mode PON Controller With Integrated Monitoring

DS1863

## ANALOG INPUT CHARACTERISTICS (BMD)

( $V_{CC} = +2.85V$  to  $+5.5V$ ;  $T_A = -40^{\circ}C$  to  $+95^{\circ}C$ , unless otherwise noted.)

PARAMETER	SYMBOL	CONDITIONS	MIN	TYP	MAX	UNITS
BMD Full-Scale Voltage Range	$V_{APC}$	(Note 4)		2.5		V
Resolution		(Note 4)		8		bits
$V_{APC}$ Error		(Note 5), $T_A = 25^{\circ}C$	-1.75		+1.75	%FS
$V_{APC}$ Integral Nonlinearity			-1		+1	LSB
$V_{APC}$ Differential Nonlinearity			-1		+1	LSB
$V_{APC}$ Temp Drift			-2.5		+2.5	%FS
Input Resistance			35	50.0	65	$k\Omega$

## ANALOG OUTPUT CHARACTERISTICS

( $V_{CC} = +2.85V$  to  $+5.5V$ ;  $T_A = -40^{\circ}C$  to  $+95^{\circ}C$ , unless otherwise noted.)

PARAMETER	SYMBOL	CONDITIONS	MIN	TYP	MAX	UNITS
BIAS Current	$I_{BIAS}$	(Note 1)		1.2		mA
$I_{BIAS}$ Shutdown Current	$I_{BIAS:OFF}$			10	100	nA
Voltage at $I_{BIAS}$			0.7	1.2	1.4	V
MOD Full-Scale Voltage	$V_{MOD}$	(Note 6)		1.25		V
MOD Output Impedance		(Note 7)		3.14		$k\Omega$
$V_{MOD}$ Error		(Note 8), $T_A = 25^{\circ}C$	-1.25		+1.25	%FS
$V_{MOD}$ Integral Nonlinearity			-1		+1	LSB
$V_{MOD}$ Differential Nonlinearity			-1		+1	LSB
$V_{MOD}$ Temperature Drift			-2		+2	%FS

## CONTROL LOOP AND QUICK-TRIP TIMING CHARACTERISTICS

( $V_{CC} = +2.85V$  to  $+5.5V$ ;  $T_A = -40^{\circ}C$  to  $+95^{\circ}C$ , unless otherwise noted.)

PARAMETER	SYMBOL	CONDITIONS	MIN	TYP	MAX	UNITS
First BMD Sample Following BEN	$t_{FIRST}$	(Note 9)				
Remaining Updates During BEN	$t_{REP}$	(Note 9)				
BEN High Time	$t_{BEN:HIGH}$		420			ns
BEN Low Time	$t_{BEN:LOW}$		96			ns
BIAS and MOD Turn-Off Delay	$t_{OFF}$				5	$\mu s$
BIAS and MOD Turn-On Delay	$t_{ON}$				5	$\mu s$
FETG Turn-On Delay	$t_{FETG:ON}$				5	$\mu s$
FETG Turn-Off Delay	$t_{FETG:OFF}$				5	$\mu s$
Binary Search Time	$t_{SEARCH}$	(Note 10)	5		13	BIAS Samples
ADC Round-Robin Time	$t_{RR}$				65	ms

# Burst-Mode PON Controller With Integrated Monitoring

## I<sup>2</sup>C AC ELECTRICAL CHARACTERISTICS

(V<sub>CC</sub> = +2.85V to +5.5V, T<sub>A</sub> = -40°C to +95°C, unless otherwise noted, see Figure 9.)

PARAMETER	SYMBOL	CONDITIONS	MIN	TYP	MAX	UNITS
SCL Clock Frequency	f <sub>SCL</sub>	(Note 11)	0		400	kHz
Clock Pulse Width Low	t <sub>LOW</sub>		1.3			μs
Clock Pulse Width High	t <sub>HIGH</sub>		0.6			μs
Bus Free Time Between STOP and START Condition	t <sub>BUF</sub>		1.3			μs
Start Hold Time	t <sub>HD:STA</sub>		0.6			μs
Start Setup Time	t <sub>SU:STA</sub>		0.6			μs
Data-In Hold Time	t <sub>HD:DAT</sub>		0		0.9	μs
Data-In Setup Time	t <sub>SU:DAT</sub>		100			ns
Rise Time of Both SDA and SCL Signals	t <sub>R</sub>	(Note 12)	20 + 0.1C <sub>B</sub>		300	ns
Fall Time of Both SDA and SCL Signals	t <sub>F</sub>	(Note 12)	20 + 0.1C <sub>B</sub>		300	ns
STOP Setup Time	t <sub>SU:STO</sub>		0.6			μs
Capacitive Load for Each Bus Line	C <sub>B</sub>	(Note 12)			400	pF
EEPROM Write Time	t <sub>W</sub>	(Note 13)			20	ms

## NONVOLATILE MEMORY CHARACTERISTICS

(V<sub>CC</sub> = +2.85V to +5.5V, unless otherwise noted.)

PARAMETER	SYMBOL	CONDITIONS	MIN	TYP	MAX	UNITS
EEPROM Write Cycles		+70°C	50,000			

**Note 1:** All voltages are referenced to ground. Currents into the IC are positive and out of the IC are negative.

**Note 2:** Digital Inputs are at rail. FETG is disconnected SDA = SCL = 1.

**Note 3:** See *Safety Shutdown (FETG) Output Section* for details.

**Note 4:** Eight ranges allow the full-scale range to change from 625mV to 2.5V.

**Note 5:** This specification applies to the expected full-scale value for the selected range. See Comp Ranging byte for available full-scale ranges.

**Note 6:** Eight ranges allow the full-scale range to change from 312.5mV to 1.25V.

**Note 7:** The output impedance of the DS1863 is proportional to its scale setting. For instance, if using the 1/2 scale, the output impedance would be 1.5kΩ.

**Note 8:** This specification applies to the expected full-scale value for the selected range. See Mod Ranging byte for available full-scale ranges.

**Note 9:** See *APC/Quick-Trip Sample Timing* section for details.

**Note 10:** Assuming an appropriate initial step is programmed that would cause the power to exceed the APC set point within 4 steps, the bias current will be within 1% within the time specified by the Binary search time.

**Note 11:** I<sup>2</sup>C interface timing shown is for fast-mode (400kHz) operation. This device is also backward-compatible with I<sup>2</sup>C standard-mode timing.

**Note 12:** C<sub>B</sub>—total capacitance of one bus line in picofarads.

**Note 13:** EEPROM write begins after a stop condition occurs.

**Note 14:** Guaranteed by design.

# Burst-Mode PON Controller With Integrated Monitoring

## Typical Operating Characteristics

( $V_{CC} = 3.3V$ ;  $T_A = +25^\circ C$ , unless otherwise noted.)

DS1863

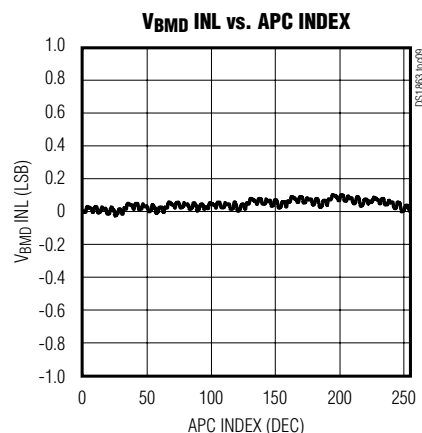
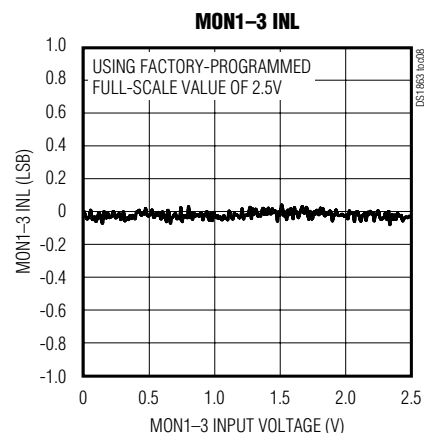
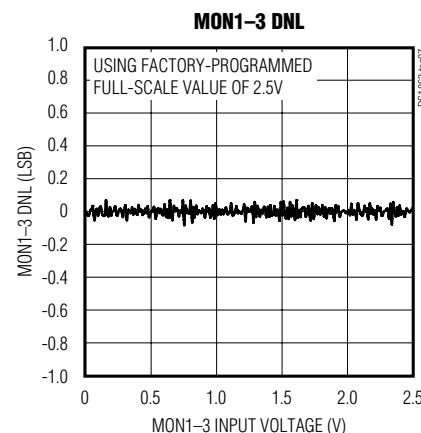
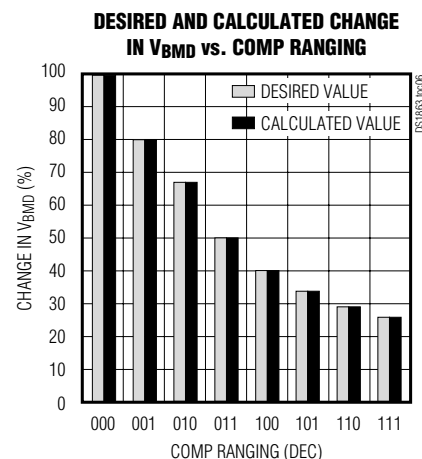
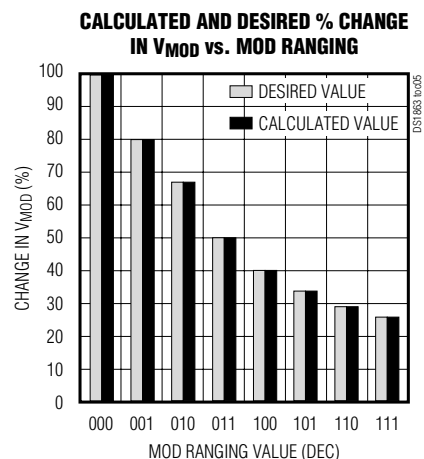
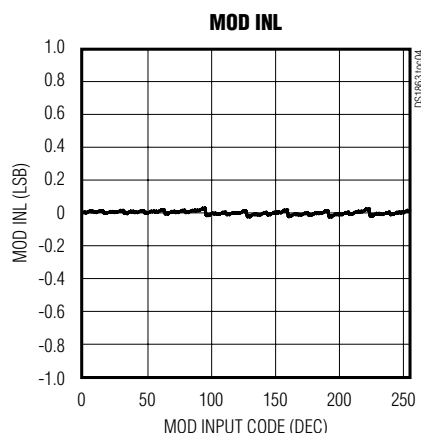
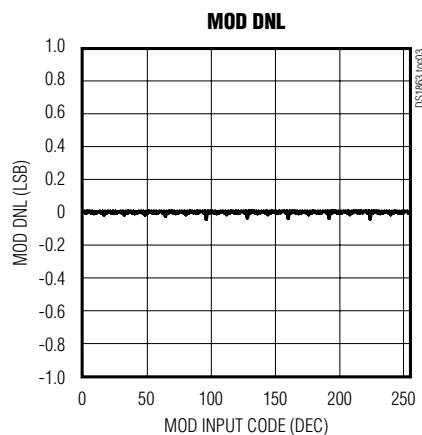
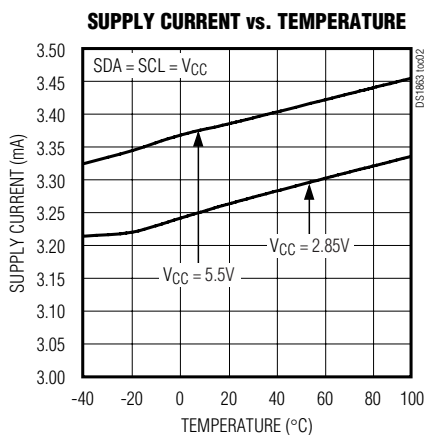
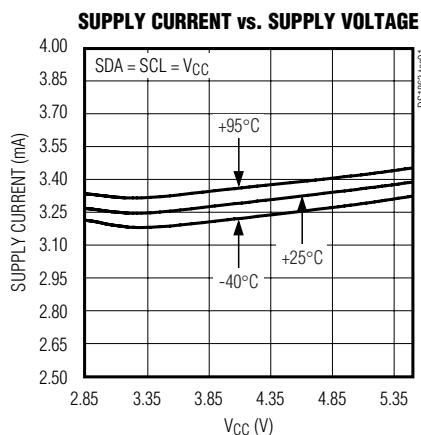

# Burst-Mode PON Controller With Integrated Monitoring

## Pin Description

PIN	NAME	DESCRIPTION
1	BEN	Burst Enable Input. Triggers the sampling of the APC and Quick-trip monitors.
2	TX-D	Transmit Disable Input. Disables BIAS and MOD outputs.
3	N.C.	No Connection
4	TX-F	Transmit Fault Output. Open-drain.
5	FETG	Output to FET Gate. Signals an external N or P Channel MOSFET to enable/disable the laser's current.
6	SDA	I <sup>2</sup> C Serial Data I/O
7	SCL	I <sup>2</sup> C Serial Clock Input
8	GND	Ground
9	MON1	External Analog Inputs. The voltage at these pins is digitized by the internal analog-to-digital converter and can be read through the I <sup>2</sup> C interface. Alarm and warning values can be assigned to interrupt the processor based on the ADC result.
10	MON2	
11	MON3	
12	GND	Ground
13	BIAS	Bias Current Output. This current DAC generates the bias current reference for the MAX3643.
14	MOD	Modulation Output Voltage. This 8-bit voltage output has 8 full-scale ranges from 1.25V to 0.3125V. This pin is connected to the MAX3643's VMSET input to control the modulation current.
15	BMD	Monitor Diode Input (Feedback Voltage, Transmit Power Monitor)
16	VCC	Power Supply Input

# Burst-Mode PON Controller With Integrated Monitoring

## Block Diagram

**DS1863**

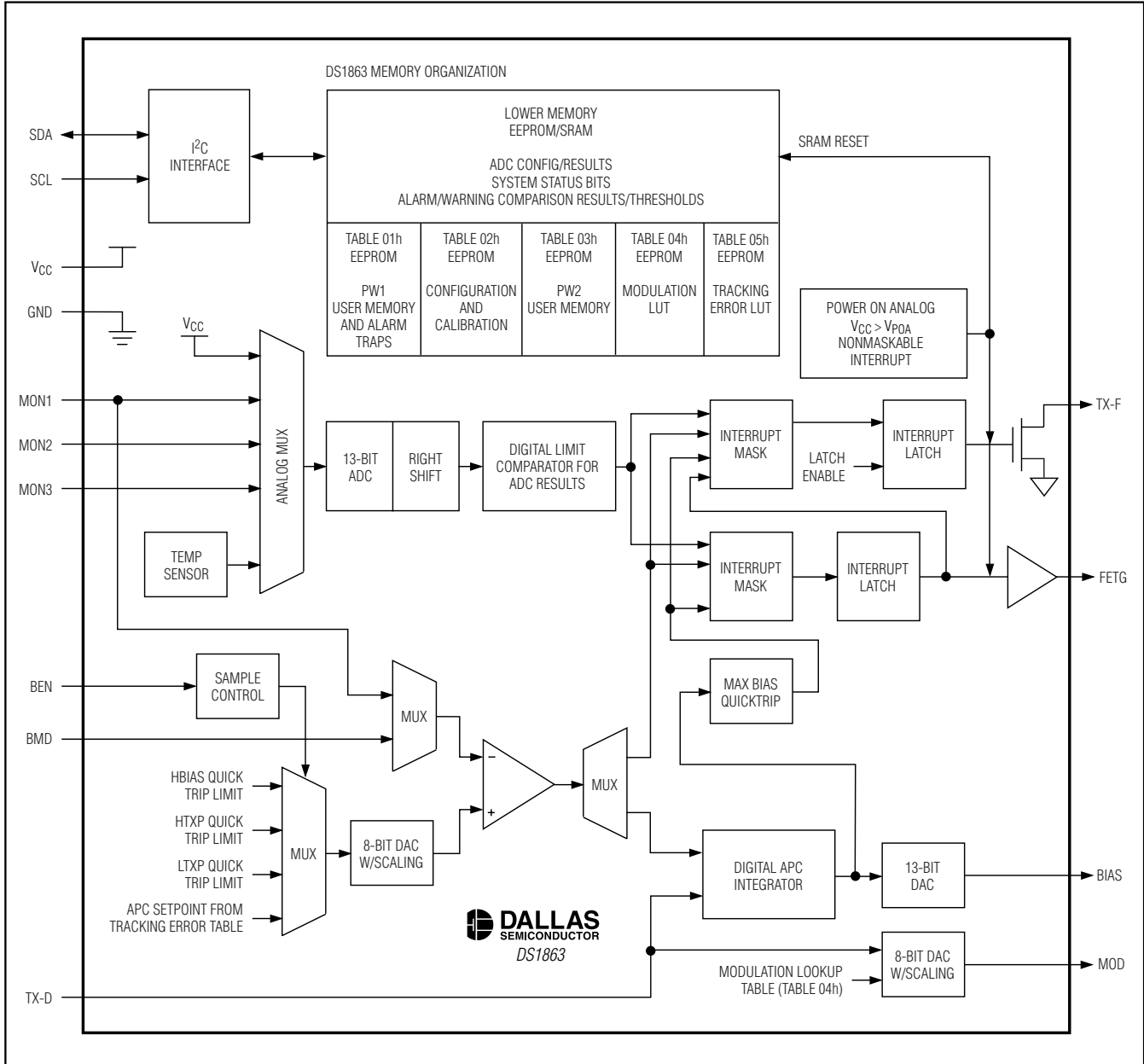

# Burst-Mode PON Controller With Integrated Monitoring

## Typical Operating Circuit

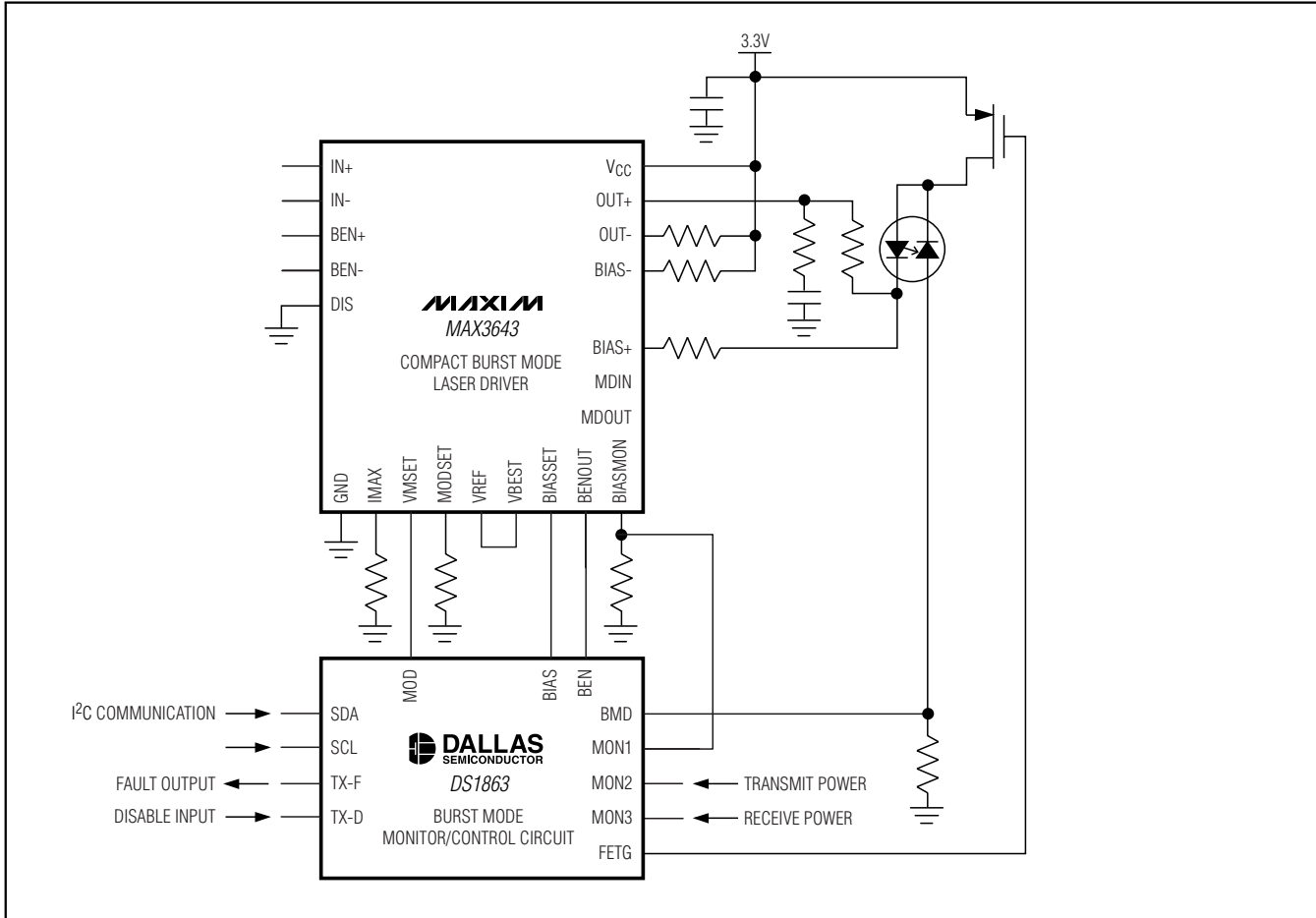

### Detailed Description

The DS1863 integrates the control and monitoring functionality required to implement a PON system using Maxim's MAX3643 compact burst mode laser driver. The compact laser driver solution offers a considerable cost benefit by integrating control and monitoring features in low power CMOS process, while leaving only the high speed portions to the laser driver IC.

#### APC Control

BIAS current is controlled by an Average Power Control (APC) loop. The APC loop uses digital techniques to overcome the difficulties associated with controlling burst mode systems.

The APC loop's feedback is the monitor diode (BMD) current, which is converted to a voltage using an external resistor. The feedback voltage is compared to an 8-bit scaleable voltage reference, which determines the APC set point of the system. Scaling of the reference voltage along with the modulation output can be utilized to implement GPON power leveling.

The DS1863 has a Lookup Table to allow the APC set point to change as a function of temperature to compensate for Tracking Error (TE). The TE LUT (Table 05h), has 36 entries that determine the APC setting in 4°C windows between -40°C to +100°C.

Ranging of the APC DAC is possible by programming a single byte in Table 02h.



# Burst-Mode PON Controller With Integrated Monitoring

## Modulation Control

The MOD voltage is controlled using an internal temperature indexed Lookup Table.

The MOD output is an 8-bit scaleable voltage output that interfaces with the MAX3643's VMSET input. An external resistor to ground from the MAX3643's MODSET pin sets the maximum current the voltage at VMSET input can produce for a given output range. This resistor value should be chosen to produce the maximum modulation current the laser type requires over temperature. The modulation LUT can be programmed in 2°C increments over the -40°C to +102°C range to provide temperature compensation for the laser's modulation. The modulation DAC's scaling can be used (with APC scaling) to implement GPON power leveling with a single LUT that works for all three power levels.

Ranging of the MOD DAC is possible by programming a single byte in Table 02h.

## BIAS and MOD Output During Initial Power-Up

On power-up the modulation and bias outputs will remain off until VCC is above VPOA, a temperature conversion has been completed, and if the VCC LO ADC alarm is enabled, then a VCC conversion above the customer defined VCC low alarm level has cleared the VCC low alarm. Once all of these conditions are satis-

fied, the MOD output will be enabled with the value determined by the temperature conversion and the modulation LUT.

When the MOD output is enabled and BEN is high, the IBIAS DAC output will be turned on to a value equal to ISTEP (see above). The start-up algorithm checks if this bias current causes a feedback voltage above the APC set-point, and if it does not it continues increasing the IBIAS by ISTEP until the APC set-point is exceeded. When the APC set point is exceeded, the device will begin a binary search to quickly reach the bias current corresponding to the proper power level. After the binary search is completed the APC integrator is enabled, and single LSB steps are taken to tightly control the average power.

All quick-trip and ADC alarm flags are masked until the binary search is completed. However, the BIAS MAX alarm is monitored during this time to prevent the bias output from exceeding MAX IBIAS. During the bias current initialization, the bias current is not allowed to exceed MAX IBIAS. If this occurs during the ISTEP sequence then the binary search routine is enabled. If MAX IBIAS is exceeded during the binary search, then the next smaller step is activated. ISTEP or binary increments that would cause IBIAS to exceed MAX IBIAS are not taken. Many of the alarm sources are likely to trip

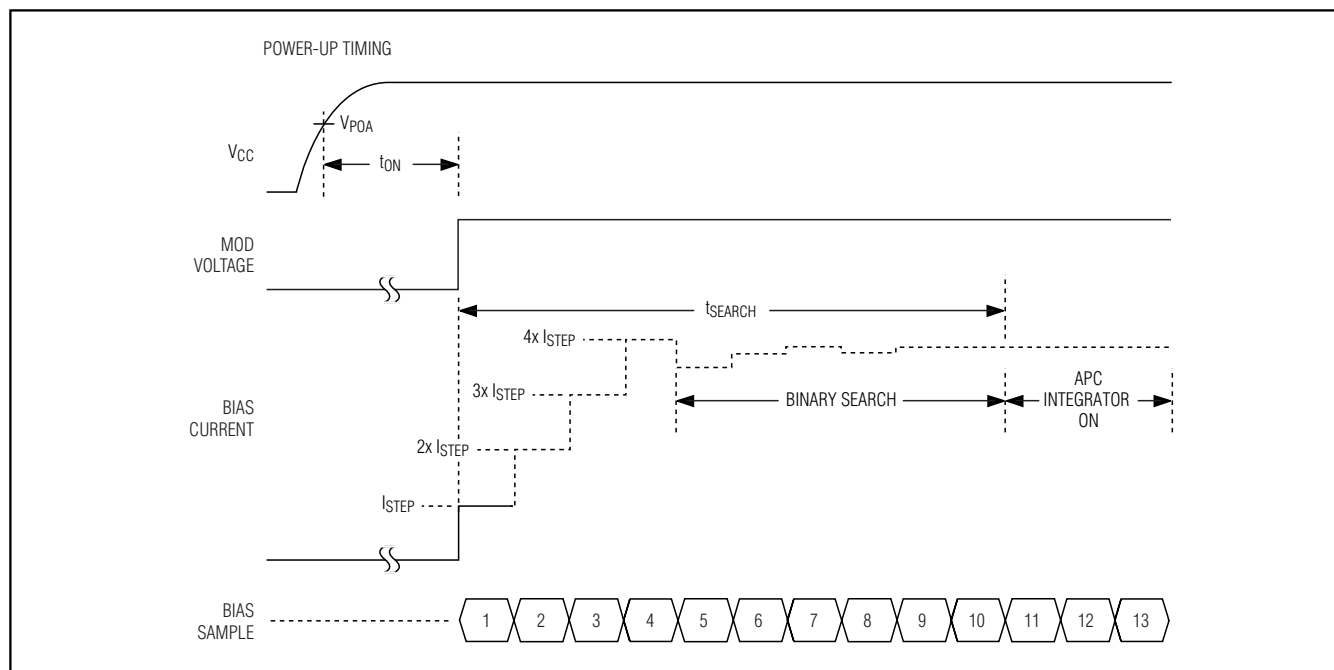

Figure 1. DS1863 Power-Up.

# Burst-Mode PON Controller With Integrated Monitoring

during start-up. Masking the alarms until the completion of the binary search prevents false alarms.

ISTEP is programmed by the customer using the Start-up Step register. This value should be programmed to the maximum safe current increase that is allowable during start-up. If this value is programmed too low, the DS1863 will still operate, but it could take significantly longer for the algorithm to converge and hence to control the average power.

If a fault is detected, and TX-D is toggled to re-enable the outputs, the DS1863 will power up following a similar sequence to an initial power up. The only difference is that the DS1863 already has determined the present temperature, so the  $t_{INIT}$  time is not required for the DS1863 to recall the APC and MOD set points from EEPROM.

## BIAS and MOD Output as a Function of Transmit Disable (TX-D)

If TX-D is asserted (logic 1) during operation, the outputs will immediately turn off ( $t_{OFF}$ ). When TX-D is deasserted (logic 0), the DS1863 will turn on the MOD output with the value associated with the present temperature, and initialize the IBIAS using the same search algorithm as done at start-up. Soft TX-D (Lower Memory, Register 6Eh) when asserted would allow a software control identical to the TX-D pin.

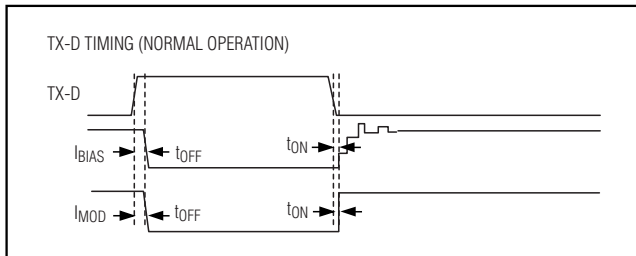

Figure 2. TX-D Timing (Output Disabled During Normal Operating Conditions).

## APC/Quick-Trip Shared Comparator Timing

The DS1863's input comparator is shared between the APC control loop and the three quick-trip alarms (HTXP, LTXP and HBIAS). The comparator polls the alarms in a round-robin multiplexed sequence. Six of every eight of the comparator readings will be used for APC Loop bias current control. The other two updates will be used to check the HTXP/LTXP (Monitor Diode voltage) and the HBIAS (MON1) signals against the

internal APC and BIAS reference. The HTXP/LTXP comparison will check HTXP if the last bias-update comparison was above the APC set-point, and LTXP if the last bias update comparison was below the APC set-point.

The DS1863 has a programmable comparator sample time based on an internally generated clock to facilitate a wide variety of external filtering options suitable for burst mode transmitter data rates between 155Mbps/s and 1250Mbps/s. The rising edge of burst enable (BEN) triggers the sample to occur, and the Sample Rate register determines the delay. The internal clock is asynchronous to BEN, causing a 100ns uncertainty as to when the first sample will occur following BEN. After the first sample occurs, subsequent samples will occur on a regular interval. The following sample rate options are available.

SR <sub>3</sub> –SR <sub>0</sub>	MINIMUM TIME FROM BEN TO FIRST SAMPLE ( $t_{FIRST}$ ) ±50ns	REPEATED SAMPLE PERIOD FOLLOWING FIRST SAMPLE ( $t_{REP}$ )
0000b	350ns	800ns
0001b	550ns	1200ns
0010b	750ns	1600ns
0011b	950ns	2000ns
0100b	1350ns	2800ns
0101b	1550ns	3200ns
0110b	1750ns	3600ns
0111b	2150ns	4400ns
1000b	2950ns	6000ns
1001b*	3150ns	6400ns

\*All codes greater than 1001b (1010b–111b) use the maximum sample time of code 1001b.

Comparisons of the HTXP, LTXP, and HBIAS quick-trip alarms will not occur during the burst enable low time. Any quick-trip alarm that is detected will by default remain active until a subsequent comparator sample shows the condition no longer exists.

A second bias current monitor compares the DS1863's bias current DAC's code to a digital value stored in the MAX IBIAS register. This comparison is made every bias current update to ensure that a high bias current will be quickly detected.

# Burst-Mode PON Controller With Integrated Monitoring

DS1863

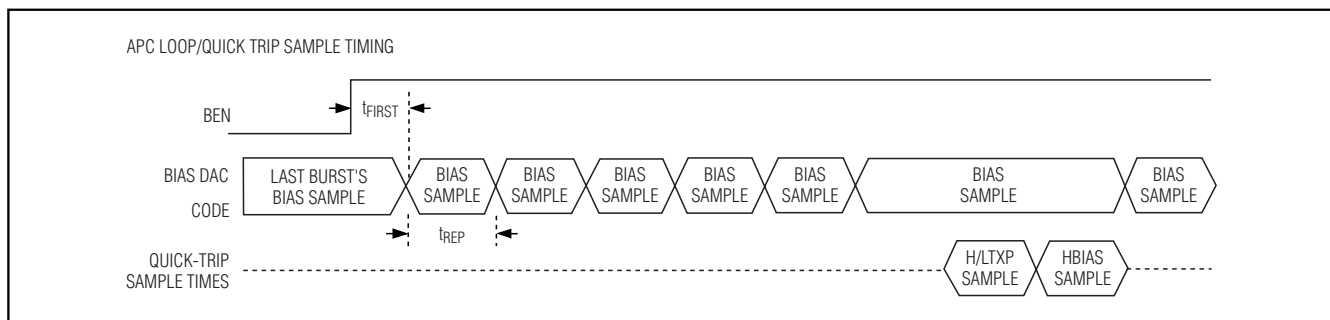

Figure 3. APC/Quick-Trip Alarm Sample Timing.

## Monitors And Fault Detection

### Monitors

Monitoring functions on the DS1863 include four quick-trip comparators and five ADC channels

This monitoring combined with the interrupt masks determines when/if the DS1863 shuts down its outputs and triggers the TX-F and FETG outputs. All of the monitoring levels and interrupt masks are user programmable with the exception of POA, which trips at a fixed range and is non-maskable for safety reasons.

### Four Quick-Trip Monitors And Alarms

Four quick-trip monitors are provided to detect potential laser safety issues. These monitor

- 1) High Bias Current (HBIAS)
- 2) Low Transmit Power (LTXP)
- 3) High Transmit Power (HTXP)
- 4) Max Output Current (MAX IBIAS)

The high and low transmit power quick-trip registers (HTXP and LTXP) set the thresholds used to compare against the BMD voltage to determine if the transmit power is within specification. The HBIAS quick-trip compares the MON1 input (generally from the MAX3643 bias monitor output) against its threshold setting to determine if the present bias current is above specification. The Max Bias quick-trip is a digital comparison that determines if the Bias Output code indicates the bias current is above specification. The bias current will not be allowed to exceed the value set in this register. When the DS1863 detects the bias is at the limit it will set the BIAS MAX status bit and hold the bias current at the MAX IBIAS level. The quick-trips are routed to the TX-F and FETG outputs via interrupt masks to allow combinations of these alarms to be used to trigger these outputs. Any time FETG is triggered the DS1863 will also disable its outputs. All the

quick-trip alarm levels and masks are programmable through the I<sup>2</sup>C interface.

### Five ADC Monitors And Alarms

The ADC monitors five channels that measure temperature (internal temp sensor), V<sub>CC</sub>, MON1, MON2, and MON3 using an analog multiplexer to measure them round robin with a single ADC. Each channel has a customer programmable full scale range and offset value that will be factory programmed to default value (see below). Additionally, MON1, MON2, and MON3 have the ability to right shift results by up to 7 bits before the results are compared to alarm thresholds or read over the I<sup>2</sup>C bus. This allows customers with specified ADC ranges to calibrate the ADC full scale to a factor of 1/2<sup>n</sup> of their specified range to measure small signals. The DS1863 can then right shift the results by n bits to maintain the bit weight of their specification.

### ADC Default Monitor Full Scale Ranges

SIGNAL (UNITS)	+ FS SIGNAL	+ FS HEX	- FS SIGNAL	- FS HEX
Temperature (°C)	127.996	7FFF	-128	8000
V <sub>CC</sub> (V)	6.5528	FFF8	0V	0000
MON1, MON2, MON3 (V)	2.4997	FFF8	0V	0000

The ADC results (after right shifting, if used) are compared to high alarm thresholds (to check if the results exceeded this threshold), the low alarm thresholds (to check if the ADC results are below this threshold) and the warning threshold after each conversion (20 comparisons total), and the corresponding alarms are set which can be used to trigger the TX-F or FETG outputs. These ADC thresholds are user programmable via the I<sup>2</sup>C interface, as are the masking registers that can be

# Burst-Mode PON Controller With Integrated Monitoring

used to prevent the alarms from triggering the TX-F and FETG outputs. See below for more detail on the TX-F and FETG outputs.

### ADC Timing

There are five analog channels that are digitized in a round robin fashion in the order shown in Figure 4. The total time required to convert all five channels is  $t_{RR}$  (see electrical specifications for details).

### Right Shifting A/D Conversion Result

If the weighting of the ADC digital reading must conform to a Predetermined Full-Scale (PFS) value defined by a specification, then right shifting can be used to adjust the PFS analog measurement range while maintaining the weighting of the ADC results. The DS1863's range is wide enough to cover all requirements; when maximum input value is far short of the FS value, right shifting can be used to obtain greater accuracy. For instance, the maximum voltage might be 1/8 of the specified PFS value, so only 1/8 of the converter's range is effective over this range. An alternative is to calibrate the ADC's full scale range to 1/8 the readable PFS value and use a right-shift value of 3. With this implementation, the resolution of the measurement has increased by a factor of 8, and because the result is digitally divided by 8 by right shifting, the bit weight of the measurement still meets the standard.

The right shift operation on the A/D converter results is carried out based on the contents of Right Shift Control Registers (Table 02h Registers 8Eh to 8Fh) in EEPROM. Three analog channels: MON1 to MON3 each have 3 bits allocated to set the number of right shifts. Up to 7 right shift operations are allowed and will be executed as a part of every conversion before the results are compared to the high and low alarm levels, or loaded into their corresponding measurement registers 62h to

69h. This is true during the setup of internal calibration as well as during subsequent data conversions.

### Transmit Fault (TX-F) Output

The TX-F output has masking registers for the five ADC alarms and the four QT alarms to select which comparisons cause it to assert. In addition, the FETG alarm is selectable via the TX-F mask to cause TX-F to assert. All alarms, with the exception of FETG, will only cause TX-F to remain active while the alarm condition persists. However, the TX-F latch bit can enable the TX-F output to remain active until it is cleared by the TX-F reset bit, TX-D, soft TX-D, or by power cycling the part. If the FETG output is configured to trigger TX-F, then it is indicating that the DS1863 is in shutdown, and will require TX-D, soft TX-D, or cycling power to reset. The ADC and Quick-trip alarms (with the exception of BIAS MAX) are ignored for the first 8-10 bias current updates during power up. Only enabled alarms will activate TX-F.

The following table shows TX-F as a function of TX-D and the alarm sources.

### TX-F as a Function of TX-D and Alarm Sources

VCC > VPOA	TX-D	NON-MASKED TX-F ALARM	TX-F
No	X	X	1
Yes	0	0	0
Yes	0	1	1
Yes	1	X	0

### Safety Shutdown (FETG) Output

The FETG output has masking registers (separate from TX-F) for the five ADC alarms and the four QT alarms to select which comparisons cause it to assert. Unlike TX-F,

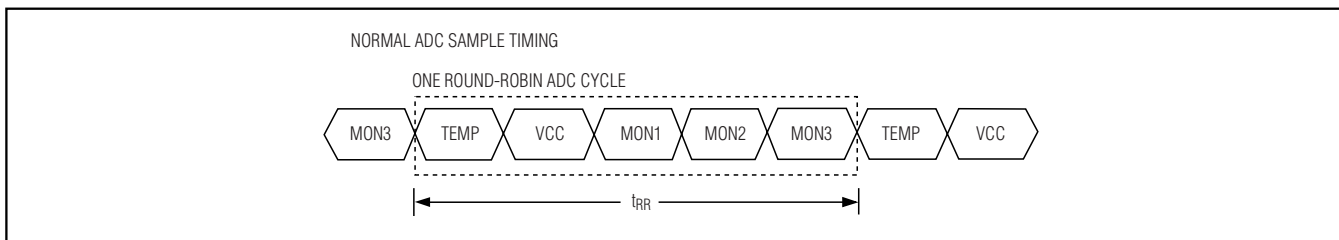

Figure 4. ADC Round-Robin Timing.

If VCC low alarm is set for either the TX-F or FETG output, the Round Robin timing will cycle between only TEMP and VCC.

# Burst-Mode PON Controller With Integrated Monitoring

DS1863

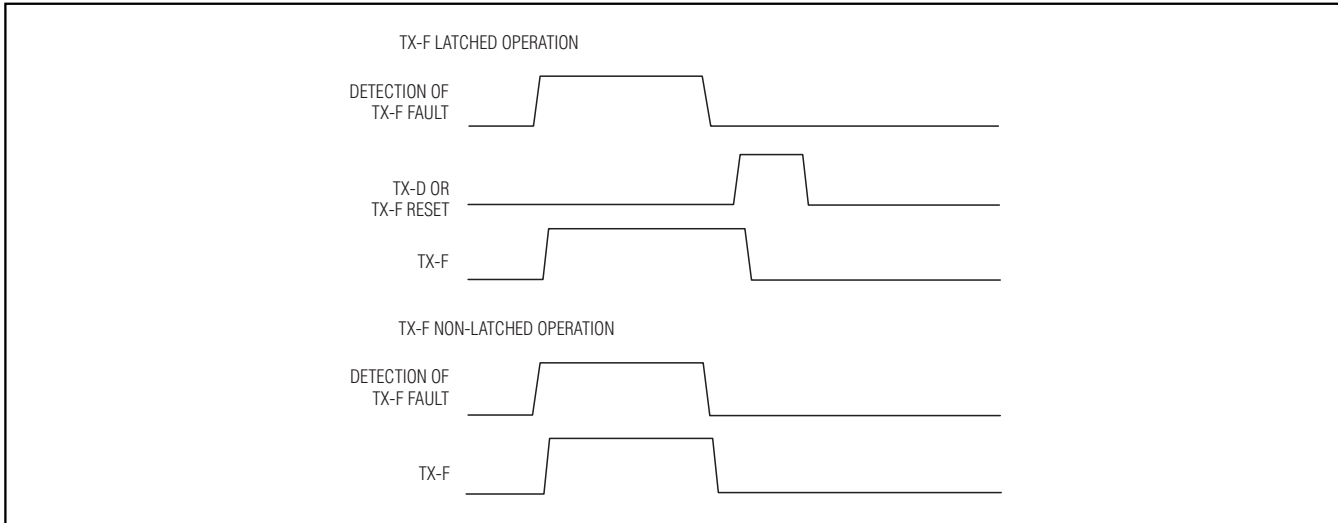

Figure 5. DS1863 TX-F Timing.

FETG output is always latched in case it is triggered by an unmasked alarm condition. Its output polarity is programmable to allow an external N or P MOSFET to open during alarms to shut off the laser diode current. If the FETG output triggers indicating the DS1863 is in shut-down, then it requires TX-D, soft TX-D, or cycling power to be reset. Under all conditions when the analog outputs are re-initialized after being disabled, all the alarms with the exception of the  $V_{CC}$  low ADC alarm will be cleared. The  $V_{CC}$  low alarm must remain active to prevent the output from attempting to operate when inadequate  $V_{CC}$  exists to operate the laser driver. Once adequate  $V_{CC}$  is present to clear the  $V_{CC}$  low alarm, the outputs will be enabled following the same sequence as power up.

As mentioned before the FETG is an output used to disable the laser current via a series N or P MOSFET. This requires that the FETG output is capable of sinking or sourcing current. Because the DS1863 will not know if it should sink or source current before  $V_{CC}$  exceeds  $V_{POA}$ , which triggers the EE recall, this output will be high impedance when  $V_{CC}$  is below  $V_{POA}$ . (see “Low Voltage Operation” section for details and diagram). The application circuit must use a pull-up or pull-down resistor on this pin that pulls FETG to the alarm/shut-down state (high for a PMOS, low for a NMOS). Once  $V_{CC}$  is above  $V_{POA}$ , the DS1863 will pull the FETG output to the state determined by the FETG DIR bit (Table 02h, Register 89h). FETG DIR will be 0 if an NMOS is used and 1 if a PMOS is used.

## FETG and MOD and BIAS Outputs as a Function of TX-D and Alarm Sources

$V_{CC} > V_{POA}$	TX-D	NON-MASKED FETG ALARM	FETG	MOD AND BIAS OUTPUTS
Yes	0	0	FETG DIR	Enabled
Yes	0	1	FETG DIR	Disabled
Yes	1	X	FETG DIR	Disabled

### Determining Alarm Causes Using The I<sup>2</sup>C Interface

To determine the cause of the TX-F or FETG alarm, the system processor can read the DS1863’s Alarm Trap Bytes (ATB) through the I<sup>2</sup>C interface (in Table 01h). The ATB have a bit for each alarm. Any time an alarm occurs, regardless of the mask bit’s state, the DS1863 sets the corresponding bit in the ATB. Active ATB bits will remain set until written to zeros via the I<sup>2</sup>C interface. On power up the ATB will be zeros until alarms dictate otherwise.

### Die Identification

DS1863 will have an ID hard coded to its die. Two registers (Table 02h bytes 86h–87h) are assigned for this feature. Byte 86h will read 63h to identify the part as the DS1863, byte 87h will read to A1h (for A1 die revision).

### Low-Voltage Operation

The DS1863 contains two Power-On Reset (POR) levels. The lower level is a Digital POR ( $V_{POD}$ ) and the

# Burst-Mode PON Controller With Integrated Monitoring

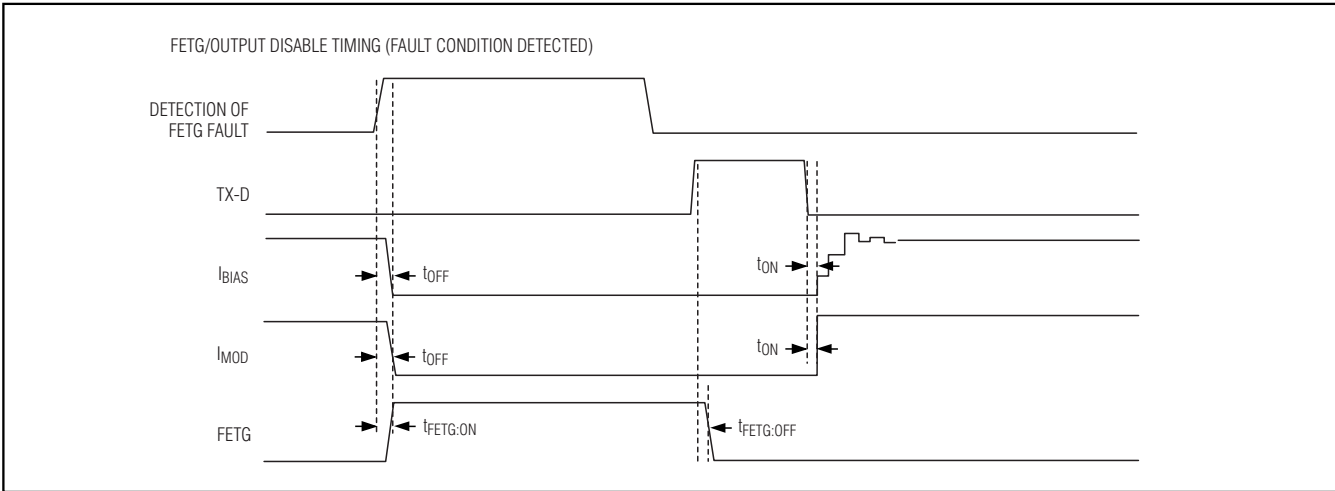

Figure 6. FETG/Modulation and Bias Timing (Fault Condition Detected).

higher level is an Analog POR ( $V_{POA}$ ). At start up, before the supply voltage rises above  $V_{POA}$ , the outputs are disabled (FETG and BIAS outputs are high impedance, MOD is low), all SRAM outputs are low (including Shadowed EEPROM), and all analog circuitry is disabled. When  $V_{CC}$  reaches  $V_{POA}$ , the SEE is recalled, and the analog circuitry is enabled. While  $V_{CC}$  remains above  $V_{POA}$ , the device is in its normal operating state, and it responds based on its non-volatile configuration. If during operation  $V_{CC}$  falls below  $V_{POA}$ , but is still above  $V_{POD}$ , then the SRAM will retain the SEE settings from the first SEE recall, but the device analog will be shut down and the outputs disabled. FETG will be driven to its alarm state defined by the FETG DIR bit (Table 02h, Register 89h). If the supply voltage recovers back above  $V_{POA}$ , then the device will immediately resume normal functioning. If the supply voltage falls below  $V_{POD}$ , then the device SRAM will be placed in its default state and another SEE recall will be required to reload the nonvolatile settings. The EEPROM recall will occur the next time  $V_{CC}$  next exceeds  $V_{POA}$ . Figure 7 shows the sequence of events as the voltage varies.

Any time  $V_{CC}$  is above  $V_{POD}$ , the I<sup>2</sup>C interface can be used to determine if  $V_{CC}$  is below the  $V_{POA}$  level. This is accomplished by checking the RDYB bit in the Status

(6Eh) byte. RDYB is set when  $V_{CC}$  is below  $V_{POA}$ ; when  $V_{CC}$  rises above  $V_{POA}$  RDYB is timed (within 500 $\mu$ s) to go to 0, at which point the part is fully functional.

For all Device Addresses sourced from EEPROM (Byte 8Ch, Table 01h in memory) the default Device Address is A2h until  $V_{CC}$  exceeds  $V_{POA}$  allowing the device address to be recalled from the EEPROM.

### Power-On Analog (POA)

POA holds the DS1863 in reset until  $V_{CC}$  is at a suitable level ( $V_{CC} > V_{POA}$ ) for the part to accurately measure with its ADC and compare analog signals with its quick-trip monitors. Because  $V_{CC}$  cannot be measured by the ADC when  $V_{CC}$  is less than  $V_{POA}$ , POA also asserts the  $V_{CC}$  low alarm, which must be cleared by a  $V_{CC}$  ADC conversion that is greater than the customer programmable  $V_{CC}$  low ADC limit. This prevents the TX-F and FETG outputs from glitching during a slow power up. The TX-F and FETG output will not latch until there is a conversion above  $V_{CC}$  low limit.

The POA alarm is non-maskable. The TX-F, and FETG outputs shuts off any time  $V_{CC}$  is below  $V_{POA}$ . See *Low Voltage Operation* section for more information.



# Burst-Mode PON Controller With Integrated Monitoring

DS1863

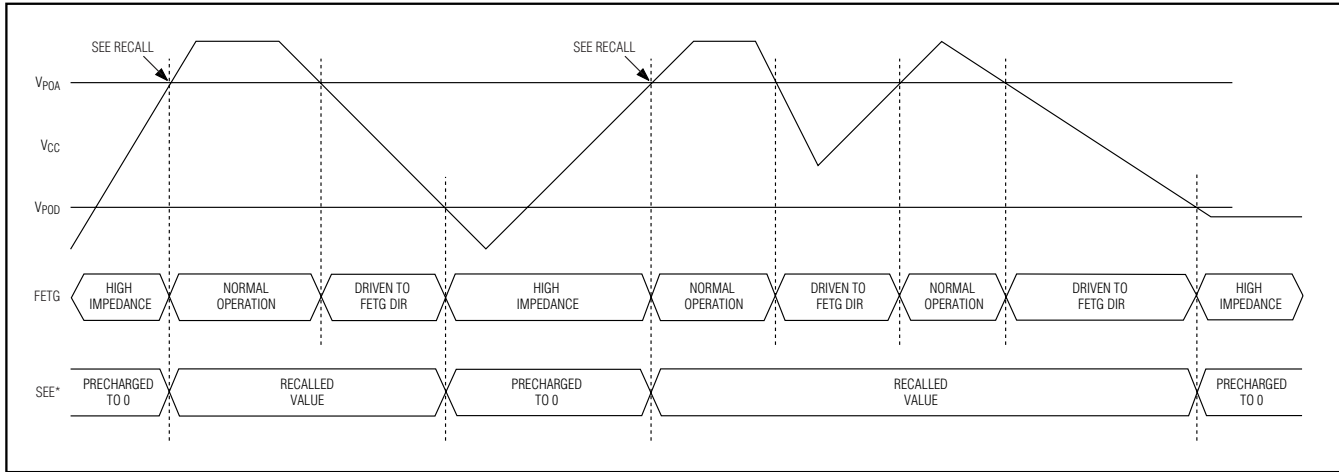

Figure 7. DS1863 Digital and Analog Power-On Reset.

## DS1863 Memory Map

### Memory Organization

The DS1863 features six memory banks that include the following.

The **Lower Memory** is addressed from 00h to 7Fh and contains alarm and warning thresholds, flags, masks, several control registers, password entry area (PWE), and the Table Select byte. The Table Select Byte determines which Table (01h–05h) will be mapped into the upper memory locations.

**Table 01h** primarily contains user EEPROM (with PW1 level access) as well as some Alarm and Warning status bytes.

**Table 02h** is a multifunction space that contains Configuration registers, scaling and offset values, Passwords, interrupt registers as well as other miscellaneous control bytes.

**Table 03h** is strictly user EEPROM that is protected by a PW2 level password.

**Table 04h** contains a temperature indexed Look up Table (LUT) for control of the modulation voltage. The modulation LUT can be programmed in 2°C increments over the -40°C to +102°C range. Access to this register is protected by a PW2 level password.

**Table 05h** contains another LUT which allows the APC set point to change as a function of temperature to compensate for Tracking Error (TE). This TE LUT, has 36 entries that determine the APC setting in 4°C windows between -40°C to 100°C. Access to this register is protected by a PW2 level password.

Complete detail of each byte's function, as well as Read/Write permissions for each Byte for each table is provided in the *Register Descriptions* sections.

### Shadowed EEPROM

Many nonvolatile (NV) memory locations (listed within the *Detailed Register Description* section) are actually Shadowed-EEPROM which are controlled by the SEEB bit in Table 02h, Byte 80h.

The DS1863 incorporates Shadowed EEPROM memory locations for key memory addresses that may be rewritten many times. By default the Shadowed EEPROM Bit, SEEB, is not set and these locations act as ordinary EEPROM. By setting SEEB these locations function like SRAM cells, which allow an infinite number of write cycles without concern of wearing out the EEPROM. This also eliminates the requirement for the EEPROM write time,  $t_{WR}$ . Because changes made with SEEB enabled do not affect the EEPROM, these changes are not retained through power cycles. The power-up value is the last value written with SEEB disabled. This function can be used to limit the number of EEPROM writes during calibration or to change the monitor thresholds periodically during normal operation helping to reduce the number of times EEPROM is written. The Memory Map description indicates which locations are shadowed-EEPROM.

# Burst-Mode PON Controller With Integrated Monitoring

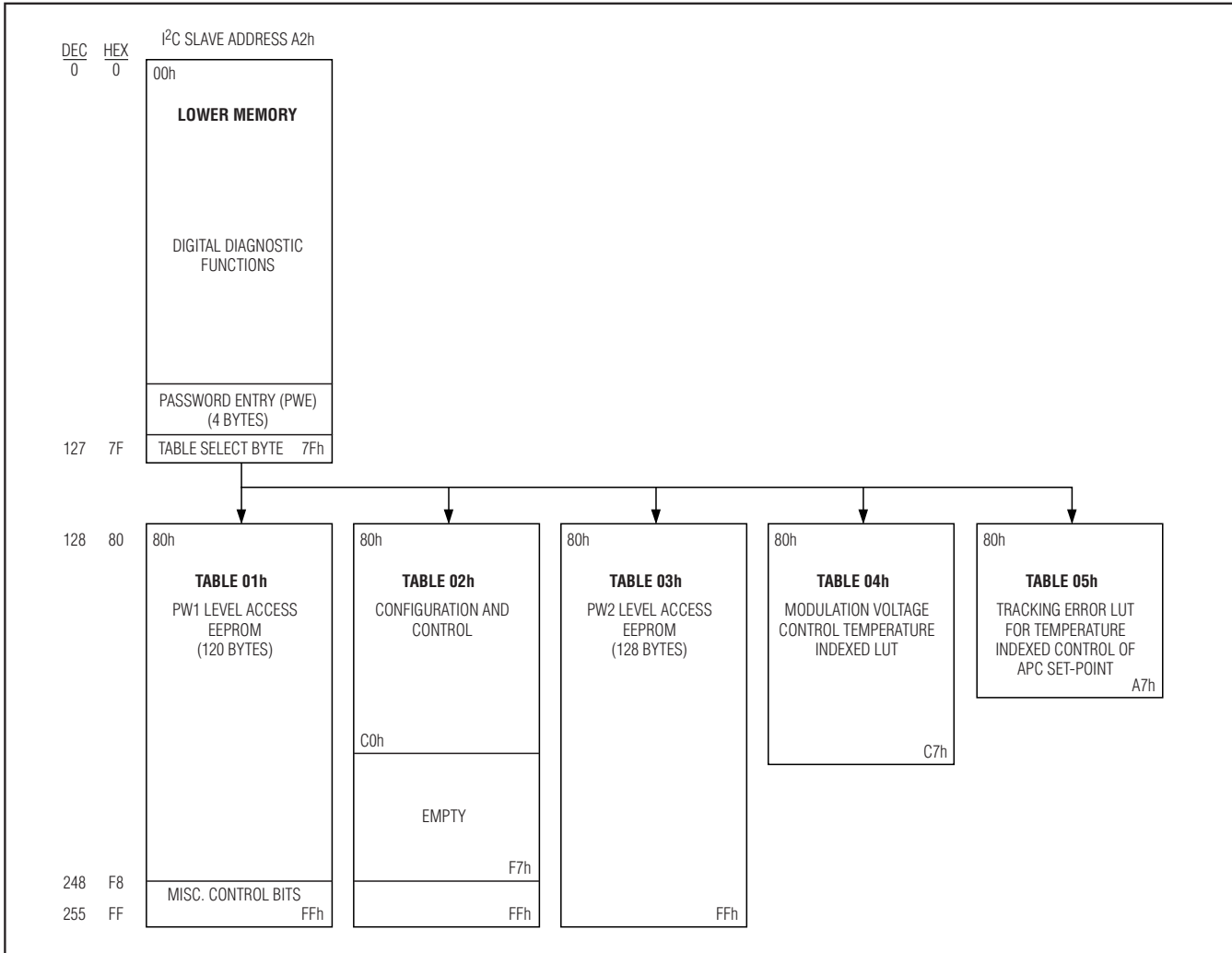

Figure 8. DS1863 Memory Map.

## I<sup>2</sup>C Definitions

**Master Device:** The master device controls the slave devices on the bus. The master device generates SCL clock pulses, START and STOP conditions.

**Slave Devices:** Slave devices send and receive data at the master's request.

**Bus Idle or Not Busy:** Time between STOP and START conditions when both SDA and SCL are inactive and in their logic-high states. When the bus is idle it often initiates a low-power mode for slave devices.

**START Condition:** A START condition is generated by the master to initiate a new data transfer with a slave.

Transitioning SDA from high to low while SCL remains high generates a START condition. See the timing diagram for applicable timing.

**STOP Condition:** A STOP condition is generated by the master to end a data transfer with a slave. Transitioning SDA from low to high while SCL remains high generates a STOP condition. See the timing diagram for applicable timing.

**Repeated START Condition:** The master can use a repeated START condition at the end of one data transfer to indicate that it will immediately initiate a new data transfer following the current one. Repeated STARTS are commonly used during read operations to identify a



# Burst-Mode PON Controller With Integrated Monitoring

specific memory address to begin a data transfer. A repeated START condition is issued identically to a normal START condition. See the timing diagram for applicable timing.

**Bit Write:** Transitions of SDA must occur during the low state of SCL. The data on SDA must remain valid and unchanged during the entire high pulse of SCL plus the setup and hold-time requirements (Figure 9). Data is shifted into the device during the rising edge of the SCL.

**Bit Read:** At the end of a write operation, the master must release the SDA bus line for the proper amount of setup time before the next rising edge of SCL during a bit read. The device shifts out each bit of data on SDA at the falling edge of the previous SCL pulse and the data bit is valid at the rising edge of the current SCL pulse. Remember that the master generates all SCL clock pulses including when it is reading bits from the slave.

**Acknowledgement (ACK and NACK):** An Acknowledgement (ACK) or Not Acknowledge (NACK) is always the 9th bit transmitted during a byte transfer. The device receiving data (the master during a read or the slave during a write operation) performs an ACK by transmitting a zero during the 9th bit. A device performs a NACK by transmitting a one during the 9th bit. Timing for the ACK and NACK is identical to all other bit writes. An ACK is the acknowledgment that the device is properly receiving data. A NACK is used to terminate a read sequence or as an indication that the device is not receiving data.

**Byte Write:** A byte write consists of 8 bits of information transferred from the master to the slave (most significant bit first) plus a 1-bit acknowledgement from the slave to the master. The 8 bits transmitted by the mas-

ter are done according to the bit write definition and the acknowledgement is read using the bit read definition.

**Byte Read:** A byte read is an 8-bit information transfer from the slave to the master plus a 1-bit ACK or NACK from the master to the slave. The 8 bits of information that are transferred (most significant bit first) from the slave to the master are read by the master using the bit read definition, and the master transmits an ACK using the bit write definition to receive additional data bytes. The master must NACK the last byte read to terminate communication so the slave will return control of SDA to the master.

**Slave Address Byte:** Each slave on the I<sup>2</sup>C bus responds to a slave addressing byte (Figure 10) sent immediately following a START condition. The slave address byte contains the slave address in the most significant 7 bits and the R/W bit in the least significant bit.

The DS1863's slave address can be configured to any value between 00h to FEh using the Device Address Byte (Table 02h, Register 8Ch). The user also has to set the ASEL bit (Table 02h, Register 89h) for this address to be active. The default address is A2h (see Figure 10). By writing the correct slave address with R/W = 0, the master indicates it will write data to the slave. If R/W = 1, the master will read data from the slave. If an incorrect slave address is written, the DS1863 will assume the master is communicating with another I<sup>2</sup>C device and ignore the communications until the next START condition is sent.

**Memory Address:** During an I<sup>2</sup>C write operation, the master must transmit a memory address to identify the memory location where the slave is to store the data. The memory address is always the second byte transmitted during a write operation following the slave address byte.

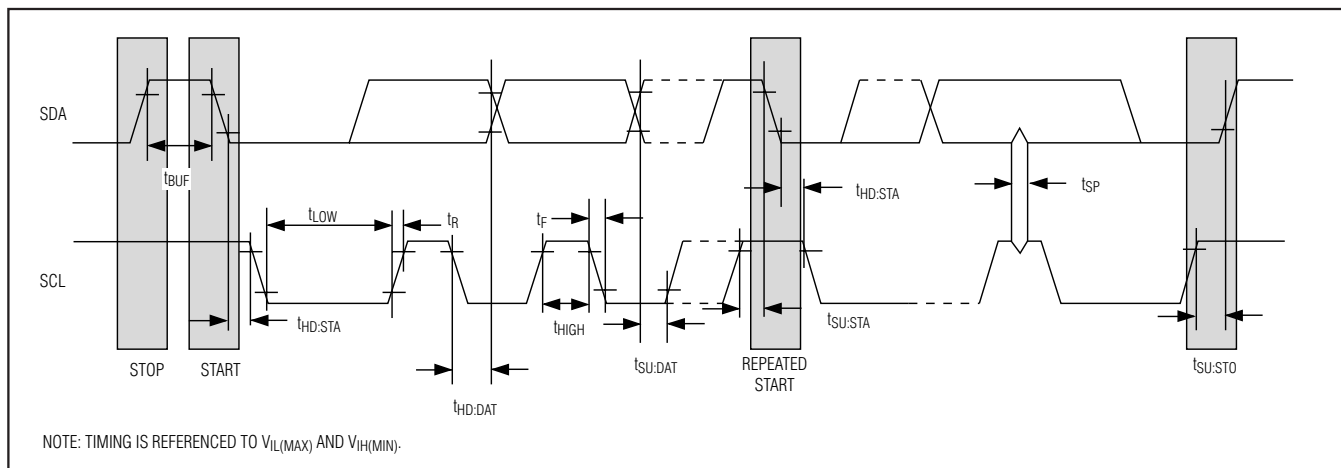

Figure 9. I<sup>2</sup>C Timing Diagram.

# Burst-Mode PON Controller With Integrated Monitoring

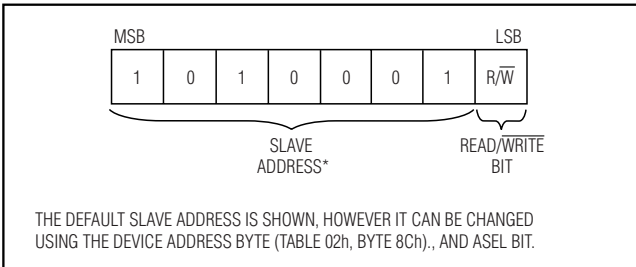

Figure 10. DS1863 Slave Address Byte (Default)

## I<sup>2</sup>C Communication

**Writing a Single Byte to a Slave:** The master must generate a START condition, write the slave address byte ( $R/\overline{W} = 0$ ), write the byte of data, and generate a STOP condition. The master must read the slave's acknowledgement during all byte write operations.

**Writing Multiple Bytes to a Slave:** To write multiple bytes to a slave, the master generates a start condition, writes the slave address byte ( $R/\overline{W} = 0$ ), writes the memory address, writes up to 8 data bytes, and generates a stop condition. The DS1863 writes 1 to 8 bytes (1 page or row) with a single write transaction. This is internally controlled by an address counter that allows data to be written to consecutive addresses without transmitting a memory address before each data byte is sent. The address counter limits the write to one 8-byte page (one row of the memory map). Attempts to write to additional pages of memory without sending a stop condition between pages results in the address counter wrapping around to the beginning of the present row.

**Example:** A 3-byte write starts at address 06h and writes three data bytes (11h, 22h, and 33h) to three "consecutive" addresses. The result is that addresses 06h and 07h would contain 11h and 22h, respectively, and the third data byte, 33h, would be written to address 00h.

To prevent address wrapping from occurring, the master must send a stop condition at the end of the page, then wait for the bus-free or EEPROM-write time to elapse. Then the master can generate a new start condition, and write the slave address byte ( $R/\overline{W} = 0$ ) and the first memory address of the next memory row before continuing to write data.

**Acknowledge Polling:** Any time an EEPROM location is written, the DS1863 requires the EEPROM write time ( $t_w$ ) after the STOP condition to write the contents of the byte of data to EEPROM. During the EEPROM write time, the device will not acknowledge its slave address because it is busy. It is possible to take advantage of that phenomenon by repeatedly addressing the DS1863, which allows the next page to be written as soon as the DS1863 is ready to receive the data. The alternative to acknowledge polling is to wait for a maximum period of  $t_w$  to elapse before attempting to write again to the device.

**EEPROM Write Cycles:** When EEPROM writes occur to the memory, the DS1863 will write to all three EEPROM memory locations, even if only a single byte was modified. Because all three bytes are written, the bytes that were not modified during the write transaction are still subject to a write cycle. This can result in all three bytes being worn out over time by writing a single byte repeatedly. The DS1863's EEPROM write cycles are specified in the *NV Memory Characteristics* table. The specification shown is at the worst-case temperature. If zero-crossing detection is enabled, EEPROM write cycles cannot begin until after the zero-crossing detection is complete.

**Reading a Single Byte from a Slave:** To read a single byte from the slave, the master generates a START condition, writes the slave address byte with  $R/\overline{W} = 1$ , reads the data byte with a NACK to indicate the end of the transfer, and generates a STOP condition. When a single byte is read, it will always be the Potentiometer 0 value.

**Reading Multiple Bytes from a Slave:** The read operation can be used to read multiple bytes with a single transfer. When reading bytes from the slave, the master simply ACKs the data byte if it desires to read another byte before terminating the transaction. After the master reads the last byte, it NACKs to indicate the end of the transfer and generates a STOP condition. The first byte read will be the Potentiometer 0 Wiper Setting. The next byte will be the Potentiometer 1 Wiper Setting. The third byte is the Configuration Register byte. If an ACK is issued by the master following the Configuration Register byte, then the DS1863 will send the Potentiometer 0 Wiper Setting again. This round robin reading will occur as long as each byte read is followed by an ACK from the master.

# Burst-Mode PON Controller With Integrated Monitoring

DS1863

## Lower Memory Register Map

This register map shows each byte/word in terms of the row it is on in the memory. The first byte in the row is located in memory at the row address (hexadecimal) in the left most column. Each subsequent byte on the row is

one/ two memory locations beyond the previous byte/word's address. A total of eight bytes are present on each row. For more information about each of these bytes see the corresponding register description.

LOWER MEMORY									
ROW (HEX)	ROW NAME	WORD 0		WORD 1		WORD 2		WORD 3	
		BYTE 0/8	BYTE 1/9	BYTE 2/A	BYTE 3/B	BYTE 4/C	BYTE 5/D	BYTE 6/E	BYTE 7/F
00	<1>THRESHOLD0	TEMP ALARM HI		TEMP ALARM LO		TEMP WARN HI		TEMP WARN LO	
08	<1>THRESHOLD1	VCC ALARM HI		VCC ALARM LO		VCC WARN HI		VCC WARN LO	
10	<1>THRESHOLD2	MON1 ALARM HI		MON1 ALARM LO		MON1 WARN HI		MON1 WARN LO	
18	<1>THRESHOLD3	MON2 ALARM HI		MON2 ALARM LO		MON2 WARN HI		MON2 WARN LO	
20	<1>THRESHOLD4	MON3 ALARM HI		MON3 ALARM LO		MON3 WARN HI		MON3 WARN LO	
28	<1>SHADOWED EE	SEE	SEE	SEE	SEE	SEE	SEE	SEE	SEE
30	<1>PW2 EE	EE	EE	EE	EE	EE	EE	EE	EE
38	<1>PW2 EE	EE	EE	EE	EE	EE	EE	EE	EE
40	<1>PW2 EE	EE	EE	EE	EE	EE	EE	EE	EE
48	<1>PW2 EE	EE	EE	EE	EE	EE	EE	EE	EE
50	<1>PW2 EE	EE	EE	EE	EE	EE	EE	EE	EE
58	<1>PW2 EE	EE	EE	EE	EE	EE	EE	EE	EE
60	<2>ADC VALUES0	TEMP VALUE		VCC VALUE		MON1 VALUE		MON2 VALUE	
68	<0> ADC VALUES1	<2>MON3 VALUE		<2>RESERVED		<2>RESERVED		<0>STATUS	<3>UPDATE
70	<2>ALARM/WARN	ALARM3	ALARM2	ALARM1	ALARM0	WARN3	WARN2	RESERVED	
78	<0>TABLE SELECT	<6>RESERVED	<6>RESERVED	<6>RESERVED	<6>PWE MSB		<6>PWE LSB		<6>TBL SEL

Access Code	<0>	<1>	<2>	<3>	<4>	<5>	<6>	<7>	<8>	<9>	<10>	<11>
Read Access	See each bit/byte separately	All	All	All	PW2	All	N/A	PW1	PW2	N/A	PW2	All
Write Access		PW2	N/A	All and DS1863 Hardware	PW2 + mode bit	All	All	PW1	PW2	PW2	N/A	PW1

# Burst-Mode PON Controller With Integrated Monitoring

## Table 01h. Register Map

TABLE 01h (PW1)									
ROW (HEX)	ROW NAME	WORD 0		WORD 1		WORD 2		WORD 3	
		BYTE 0/8	BYTE 1/9	BYTE 2/A	BYTE 3/B	BYTE 4/C	BYTE 5/D	BYTE 6/E	BYTE 7/F
80	<7>PW1 EE	EE	EE	EE	EE	EE	EE	EE	EE
88	<7>PW1 EE	EE	EE	EE	EE	EE	EE	EE	EE
90	<7>PW1 EE	EE	EE	EE	EE	EE	EE	EE	EE
98	<7>PW1 EE	EE	EE	EE	EE	EE	EE	EE	EE
A0	<7>PW1 EE	EE	EE	EE	EE	EE	EE	EE	EE
A8	<7>PW1 EE	EE	EE	EE	EE	EE	EE	EE	EE
B0	<7>PW1 EE	EE	EE	EE	EE	EE	EE	EE	EE
B8	<7>PW1 EE	EE	EE	EE	EE	EE	EE	EE	EE
C0	<7>PW1 EE	EE	EE	EE	EE	EE	EE	EE	EE
C8	<7>PW1 EE	EE	EE	EE	EE	EE	EE	EE	EE
D0	<7>PW1 EE	EE	EE	EE	EE	EE	EE	EE	EE
D8	<7>PW1 EE	EE	EE	EE	EE	EE	EE	EE	EE
E0	<7>PW1 EE	EE	EE	EE	EE	EE	EE	EE	EE
E8	<7>PW1 EE	EE	EE	EE	EE	EE	EE	EE	EE
F0	<7>PW1 EE	EE	EE	EE	EE	EE	EE	EE	EE
F8	<11>ALARM TRAP	ALARM <sub>3</sub>	ALARM <sub>2</sub>	ALARM <sub>1</sub>	ALARM <sub>0</sub>	WARN <sub>3</sub>	WARN <sub>2</sub>	RESERVED	

Access Code	<0>	<1>	<2>	<3>	<4>	<5>	<6>	<7>	<8>	<9>	<10>	<11>
Read Access	See each bit/byte separately	All	All	All	PW2	All	N/A	PW1	PW2	N/A	PW2	All
Write Access		PW2	N/A	All and DS1863 Hardware	PW2 + mode bit	All	All	PW1	PW2	PW2	N/A	PW1

# Burst-Mode PON Controller With Integrated Monitoring

DS1863

**Table 02h. Register Map**

TABLE 02h (PW2)									
ROW (HEX)	ROW NAME	WORD 0		WORD 1		WORD 2		WORD 3	
		BYTE 0/8	BYTE 1/9	BYTE 2/A	BYTE 3/B	BYTE 4/C	BYTE 5/D	BYTE 6/E	BYTE 7/F
80	<0>CONFIG0	<8>MODE	<4>TINDEX	<4>MOD DAC	<4>APC DAC	<4>BIAS DAC2	<4>BIAS DAC2	<10>DEVICE ID	<10>DEVICE VER
88	<8>CONFIG1	UPDATE RATE	CONFIG	START-UP STEP	MOD RANGING	DEVICE ADDRESS	COMP RANGING	RSHIFT1	RSHIFT0
90	<8>SCALE0	RESERVED		VCC SCALE		MON1 SCALE		MON2 SCALE	
98	<8>SCALE1	MON3 SCALE		RESERVED		RESERVED		RESERVED	
A0	<8>OFFSET0	RESERVED		VCC OFFSET		MON1 OFFSET		MON2 OFFSET	
A8	<8>OFFSET1	MON3 OFFSET		RESERVED		RESERVED		INTERNAL TEMP OFFSET*	
B0	<9>PWD VALUE	PW1 MSB		PW1 LSB		PW2 MSB		PW2 LSB	
B8	<8>INTERRUPT	FETG EN1	FETG EN0	TX-F EN1	TX-F EN0	HXP	LXP	HBIAS	MAX IBIAS
C0-F7	EMPTY	EMPTY	EMPTY	EMPTY	EMPTY	EMPTY	EMPTY	EMPTY	EMPTY
F8	<4>MAN IBIAS	MAN IBIAS0	MAN IBIAS1	MAN_CNTRL	RESERVED	RESERVED	RESERVED	RESERVED	RESERVED

\*The Final Result must be XOR'ed with BB40h before writing to this register.

Access Code	<0>	<1>	<2>	<3>	<4>	<5>	<6>	<7>	<8>	<9>	<10>	<11>
Read Access	See each bit/byte separately	All	All	All	PW2	All	N/A	PW1	PW2	N/A	PW2	All
Write Access		PW2	N/A	All and DS1863 Hardware	PW2 + mode bit	All	All	PW1	PW2	PW2	N/A	PW1

# Burst-Mode PON Controller With Integrated Monitoring

Table 03h. Register Map

TABLE 03h (PW2)									
ROW (HEX)	ROW NAME	WORD 0		WORD 1		WORD 2		WORD 3	
		BYTE 0/8	BYTE 1/9	BYTE 2/A	BYTE 3/B	BYTE 4/C	BYTE 5/D	BYTE 6/E	BYTE 7/F
80	<b>PW2 EE	EE	EE	EE	EE	EE	EE	EE	EE
88	<b>PW2 EE	EE	EE	EE	EE	EE	EE	EE	EE
90	<b>PW2 EE	EE	EE	EE	EE	EE	EE	EE	EE
98	<b>PW2 EE	EE	EE	EE	EE	EE	EE	EE	EE
A0	<b>PW2 EE	EE	EE	EE	EE	EE	EE	EE	EE
A8	<b>PW2 EE	EE	EE	EE	EE	EE	EE	EE	EE
B0	<b>PW2 EE	EE	EE	EE	EE	EE	EE	EE	EE
B8	<b>PW2 EE	EE	EE	EE	EE	EE	EE	EE	EE
C0	<b>PW2 EE	EE	EE	EE	EE	EE	EE	EE	EE
C8	<b>PW2 EE	EE	EE	EE	EE	EE	EE	EE	EE
D0	<b>PW2 EE	EE	EE	EE	EE	EE	EE	EE	EE
D8	<b>PW2 EE	EE	EE	EE	EE	EE	EE	EE	EE
E0	<b>PW2 EE	EE	EE	EE	EE	EE	EE	EE	EE
E8	<b>PW2 EE	EE	EE	EE	EE	EE	EE	EE	EE
F0	<b>PW2 EE	EE	EE	EE	EE	EE	EE	EE	EE
F8	<b>PW2 EE	EE	EE	EE	EE	EE	EE	EE	EE

Access Code	<0>	<1>	<2>	<3>	<4>	<5>	<6>	<7>	<8>	<9>	<10>	<11>
Read Access	See each bit/byte separately	All	All	All	PW2	All	N/A	PW1	PW2	N/A	PW2	All
Write Access		PW2	N/A	All and DS1863 Hardware	PW2 + mode bit	All	All	PW1	PW2	PW2	N/A	PW1

# Burst-Mode PON Controller With Integrated Monitoring

DS1863

**Table 04h. Register Map**

TABLE 04h (LUT FOR MOD)									
ROW (HEX)	ROW NAME	WORD 0		WORD 1		WORD 2		WORD 3	
		BYTE 0/8	BYTE 1/9	BYTE 2/A	BYTE 3/B	BYTE 4/C	BYTE 5/D	BYTE 6/E	BYTE 7/F
80	<8>LUT4	MOD	MOD	MOD	MOD	MOD	MOD	MOD	MOD
88	<8>LUT4	MOD	MOD	MOD	MOD	MOD	MOD	MOD	MOD
90	<8>LUT4	MOD	MOD	MOD	MOD	MOD	MOD	MOD	MOD
98	<8>LUT4	MOD	MOD	MOD	MOD	MOD	MOD	MOD	MOD
A0	<8>LUT4	MOD	MOD	MOD	MOD	MOD	MOD	MOD	MOD
A8	<8>LUT4	MOD	MOD	MOD	MOD	MOD	MOD	MOD	MOD
B0	<8>LUT4	MOD	MOD	MOD	MOD	MOD	MOD	MOD	MOD
B8	<8>LUT4	MOD	MOD	MOD	MOD	MOD	MOD	MOD	MOD
C0	<8>LUT4	MOD	MOD	MOD	MOD	MOD	MOD	MOD	MOD

**Table 05h. Register Map**

TABLE 05h (LUT FOR APC)									
ROW (HEX)	ROW NAME	WORD 0		WORD 1		WORD 2		WORD 3	
		BYTE 0/8	BYTE 1/9	BYTE 2/A	BYTE 3/B	BYTE 4/C	BYTE 5/D	BYTE 6/E	BYTE 7/F
80	<8>LUT5	APC REF	APC REF	APC REF	APC REF	APC REF	APC REF	APC REF	APC REF
88	<8>LUT5	APC REF	APC REF	APC REF	APC REF	APC REF	APC REF	APC REF	APC REF
90	<8>LUT5	APC REF	APC REF	APC REF	APC REF	APC REF	APC REF	APC REF	APC REF
98	<8>LUT5	APC REF	APC REF	APC REF	APC REF	APC REF	APC REF	APC REF	APC REF
A0	<8>LUT5	APC REF	APC REF	APC REF	APC REF	RESERVED	RESERVED	RESERVED	RESERVED

Access Code	<0>	<1>	<2>	<3>	<4>	<5>	<6>	<7>	<8>	<9>	<10>	<11>
Read Access	See each bit/byte separately	All	All	All	PW2	All	N/A	PW1	PW2	N/A	PW2	All
Write Access	See each bit/byte separately	PW2	N/A	All and DS1863 Hardware	PW2 + mode bit	All	All	PW1	PW2	PW2	N/A	PW1

# Burst-Mode PON Controller With Integrated Monitoring

## Lower Memory Registers Description

### Lower Memory Register 00h to 01h: Temp Alarm Hi

FACTORY DEFAULT: 7FFFh  
 READ ACCESS All  
 WRITE ACCESS PW2  
 MEMORY TYPE: Nonvolatile (SEE)

00h	S	$2^6$	$2^5$	$2^4$	$2^3$	$2^2$	$2^1$	$2^0$
01h	$2^1$	$2^2$	$2^3$	$2^4$	$2^5$	$2^6$	$2^7$	$2^8$
	bit7							bit0

Temperature measurements above this 2's complement threshold will set its corresponding alarm bit. Measurements equal to or below this threshold will clear its alarm bit.

### Lower Memory Register 02h to 03h: Temp Alarm Lo

FACTORY DEFAULT: 8000h  
 READ ACCESS All  
 WRITE ACCESS PW2  
 MEMORY TYPE: Nonvolatile (SEE)

02h	S	$2^6$	$2^5$	$2^4$	$2^3$	$2^2$	$2^1$	$2^0$
03h	$2^1$	$2^2$	$2^3$	$2^4$	$2^5$	$2^6$	$2^7$	$2^8$
	bit7							bit0

Temperature measurements above this 2's complement threshold will set its corresponding alarm bit. Measurements equal to or below this threshold will clear its alarm bit.

### Lower Memory Register 04h to 05h: Temp Warn Hi

FACTORY DEFAULT: 7FFFh  
 READ ACCESS All  
 WRITE ACCESS PW2  
 MEMORY TYPE: Nonvolatile (SEE)

04h	S	$2^6$	$2^5$	$2^4$	$2^3$	$2^2$	$2^1$	$2^0$
05h	$2^1$	$2^2$	$2^3$	$2^4$	$2^5$	$2^6$	$2^7$	$2^8$
	bit7							bit0

Temperature measurements above this 2's complement threshold will set its corresponding warning bit. Measurements equal to or below this threshold will clear its warning bit.



# Burst-Mode PON Controller With Integrated Monitoring

## Lower Memory Register 06h to 07h: Temp Warn Lo

FACTORY DEFAULT: 8000h  
 READ ACCESS All  
 WRITE ACCESS PW2  
 MEMORY TYPE: Nonvolatile (SEE)

06h	S	$2^6$	$2^5$	$2^4$	$2^3$	$2^2$	$2^1$	$2^0$	
07h	$2^7$	$2^6$	$2^5$	$2^4$	$2^3$	$2^2$	$2^1$	$2^0$	
	bit7								bit0

Temperature measurements below this 2's complement threshold will set its corresponding warning bit. Measurements above this threshold will clear its warning bit.

## Lower Memory Register 08h to 09h: V<sub>CC</sub> Alarm Hi

FACTORY DEFAULT: FFFFh  
 READ ACCESS All  
 WRITE ACCESS PW2  
 MEMORY TYPE: Nonvolatile (SEE)

08h	$2^{15}$	$2^{14}$	$2^{13}$	$2^{12}$	$2^{11}$	$2^{10}$	$2^9$	$2^8$	
09h	$2^7$	$2^6$	$2^5$	$2^4$	$2^3$	$2^2$	$2^1$	$2^0$	
	bit7								bit0

Voltage measurements of the V<sub>CC</sub> input above this unsigned threshold will set its corresponding alarm bit. Measurements below this threshold will clear its alarm bit.

## Lower Memory Register 0Ah to 0Bh: V<sub>CC</sub> Alarm Lo

FACTORY DEFAULT: 0000h  
 READ ACCESS All  
 WRITE ACCESS PW2  
 MEMORY TYPE: Nonvolatile (SEE)

0Ah	$2^{15}$	$2^{14}$	$2^{13}$	$2^{12}$	$2^{11}$	$2^{10}$	$2^9$	$2^8$	
0Bh	$2^7$	$2^6$	$2^5$	$2^4$	$2^3$	$2^2$	$2^1$	$2^0$	
	bit7								bit0

Voltage measurements of the V<sub>CC</sub> below above this unsigned threshold will set its corresponding alarm bit. Measurements above this threshold will clear its alarm bit.

# Burst-Mode PON Controller With Integrated Monitoring

## Lower Memory Register 0Ch to 0Dh: V<sub>CC</sub> Alarm Hi

FACTORY DEFAULT: FFFFh

READ ACCESS All

WRITE ACCESS PW2

MEMORY TYPE: Nonvolatile (SEE)

0Ch	2 <sup>15</sup>	2 <sup>14</sup>	2 <sup>13</sup>	2 <sup>12</sup>	2 <sup>11</sup>	2 <sup>10</sup>	2 <sup>9</sup>	2 <sup>8</sup>	
0Dh	2 <sup>7</sup>	2 <sup>6</sup>	2 <sup>5</sup>	2 <sup>4</sup>	2 <sup>3</sup>	2 <sup>2</sup>	2 <sup>1</sup>	2 <sup>0</sup>	
	bit7								bit0

Voltage measurements of the V<sub>CC</sub> input above this unsigned threshold will set its corresponding warning bit. Measurements below this threshold will clear its warning bit.

## Lower Memory Register 0Eh to 0Fh: V<sub>CC</sub> Warn Lo

FACTORY DEFAULT: 0000h

READ ACCESS All

WRITE ACCESS PW2

MEMORY TYPE: Nonvolatile (SEE)

0Eh	2 <sup>15</sup>	2 <sup>14</sup>	2 <sup>13</sup>	2 <sup>12</sup>	2 <sup>11</sup>	2 <sup>10</sup>	2 <sup>9</sup>	2 <sup>8</sup>	
0Fh	2 <sup>7</sup>	2 <sup>6</sup>	2 <sup>5</sup>	2 <sup>4</sup>	2 <sup>3</sup>	2 <sup>2</sup>	2 <sup>1</sup>	2 <sup>0</sup>	
	bit7								bit0

Voltage measurements of the V<sub>CC</sub> below above this unsigned threshold will set its corresponding warning bit. Measurements above this threshold will clear its warning bit.

## Lower Memory Register 10h to 11h: MON1 Alarm Hi

FACTORY DEFAULT: FFFFh

READ ACCESS All

WRITE ACCESS PW2

MEMORY TYPE: Nonvolatile (SEE)

10h	2 <sup>15</sup>	2 <sup>14</sup>	2 <sup>13</sup>	2 <sup>12</sup>	2 <sup>11</sup>	2 <sup>10</sup>	2 <sup>9</sup>	2 <sup>8</sup>	
11h	2 <sup>7</sup>	2 <sup>6</sup>	2 <sup>5</sup>	2 <sup>4</sup>	2 <sup>3</sup>	2 <sup>2</sup>	2 <sup>1</sup>	2 <sup>0</sup>	
	bit7								bit0

Voltage measurements of the MON1 input above this unsigned threshold will set its corresponding alarm bit. Measurements below this threshold will clear its alarm bit.

# Burst-Mode PON Controller With Integrated Monitoring

## Lower Memory Register 12h to 13h: MON1 Alarm Lo

FACTORY DEFAULT: 0000h

READ ACCESS All

WRITE ACCESS PW2

MEMORY TYPE: Nonvolatile (SEE)

12h	$2^{15}$	$2^{14}$	$2^{13}$	$2^{12}$	$2^{11}$	$2^{10}$	$2^9$	$2^8$	
13h	$2^7$	$2^6$	$2^5$	$2^4$	$2^3$	$2^2$	$2^1$	$2^0$	
	bit7								bit0

Voltage measurements of the MON1 input below this unsigned threshold will set its corresponding alarm bit. Measurements above this threshold will clear its alarm bit.

## Lower Memory Register 14h to 15h: MON1 Warn Hi

FACTORY DEFAULT: FFFFh

READ ACCESS All

WRITE ACCESS PW2

MEMORY TYPE: Nonvolatile (SEE)

14h	$2^{15}$	$2^{14}$	$2^{13}$	$2^{12}$	$2^{11}$	$2^{10}$	$2^9$	$2^8$	
15h	$2^7$	$2^6$	$2^5$	$2^4$	$2^3$	$2^2$	$2^1$	$2^0$	
	bit7								bit0

Voltage measurements of the MON1 input above this unsigned threshold will set its corresponding warning bit. Measurements below this threshold will clear its warning bit.

## Lower Memory Register 16h to 17h: MON1 Warn Lo

FACTORY DEFAULT: 0000h

READ ACCESS All

WRITE ACCESS PW2

MEMORY TYPE: Nonvolatile (SEE)

16h	$2^{15}$	$2^{14}$	$2^{13}$	$2^{12}$	$2^{11}$	$2^{10}$	$2^9$	$2^8$	
17h	$2^7$	$2^6$	$2^5$	$2^4$	$2^3$	$2^2$	$2^1$	$2^0$	
	bit7								bit0

Voltage measurements of the MON1 input below this unsigned threshold will set its corresponding warning bit. Measurements above this threshold will clear its warning bit.

# Burst-Mode PON Controller With Integrated Monitoring

## Lower Memory Register 18h to 19h: MON2 Alarm Hi

FACTORY DEFAULT: FFFFh  
 READ ACCESS: All  
 WRITE ACCESS: PW2  
 MEMORY TYPE: Nonvolatile (SEE)

18h	$2^{15}$	$2^{14}$	$2^{13}$	$2^{12}$	$2^{11}$	$2^{10}$	$2^9$	$2^8$	
19h	$2^7$	$2^6$	$2^5$	$2^4$	$2^3$	$2^2$	$2^1$	$2^0$	
	bit7								bit0

Voltage measurements of the MON2 input above this unsigned threshold will set its corresponding alarm bit. Measurements below this threshold will clear its alarm bit.

## Lower Memory Register 1Ah to 1Bh: MON2 Alarm Lo

FACTORY DEFAULT: 0000h  
 READ ACCESS: All  
 WRITE ACCESS: PW2  
 MEMORY TYPE: Nonvolatile (SEE)

1Ah	$2^{15}$	$2^{14}$	$2^{13}$	$2^{12}$	$2^{11}$	$2^{10}$	$2^9$	$2^8$	
1Bh	$2^7$	$2^6$	$2^5$	$2^4$	$2^3$	$2^2$	$2^1$	$2^0$	
	bit7								bit0

Voltage measurements of the MON2 input below this unsigned threshold will set its corresponding alarm bit. Measurements above this threshold will clear its alarm bit.

## Lower Memory Register 1Ch to 1Dh: MON2 Alarm Hi

FACTORY DEFAULT: FFFFh  
 READ ACCESS: All  
 WRITE ACCESS: PW2  
 MEMORY TYPE: Nonvolatile (SEE)

1Ch	$2^{15}$	$2^{14}$	$2^{13}$	$2^{12}$	$2^{11}$	$2^{10}$	$2^9$	$2^8$	
1Dh	$2^7$	$2^6$	$2^5$	$2^4$	$2^3$	$2^2$	$2^1$	$2^0$	
	bit7								bit0

Voltage measurements of the MON2 input above this unsigned threshold will set its corresponding warning bit. Measurements below this threshold will clear its warning bit.

# Burst-Mode PON Controller With Integrated Monitoring

## Lower Memory Register 1Eh to 1Fh: MON2 Warn Lo

FACTORY DEFAULT: 0000h

READ ACCESS All

WRITE ACCESS PW2

MEMORY TYPE: Nonvolatile (SEE)

1Eh	$2^{15}$	$2^{14}$	$2^{13}$	$2^{12}$	$2^{11}$	$2^{10}$	$2^9$	$2^8$
1Fh	$2^7$	$2^6$	$2^5$	$2^4$	$2^3$	$2^2$	$2^1$	$2^0$
	bit7				bit0			

Voltage measurements of the MON2 input below this unsigned threshold will set its corresponding warning bit. Measurements above this threshold will clear its warning bit.

## Lower Memory Register 20h to 21h: MON3 Alarm Hi

FACTORY DEFAULT: FFFFh

READ ACCESS All

WRITE ACCESS PW2

MEMORY TYPE: Nonvolatile (SEE)

20h	$2^{15}$	$2^{14}$	$2^{13}$	$2^{12}$	$2^{11}$	$2^{10}$	$2^9$	$2^8$
21h	$2^7$	$2^6$	$2^5$	$2^4$	$2^3$	$2^2$	$2^1$	$2^0$
	bit7				bit0			

Voltage measurements of the MON3 input above this unsigned threshold will set its corresponding alarm bit. Measurements below this threshold will clear its alarm bit.

## Lower Memory Register 22h to 23h: MON3 Alarm Lo

FACTORY DEFAULT: 0000h

READ ACCESS All

WRITE ACCESS PW2

MEMORY TYPE: Nonvolatile (SEE)

22h	$2^{15}$	$2^{14}$	$2^{13}$	$2^{12}$	$2^{11}$	$2^{10}$	$2^9$	$2^8$
23h	$2^7$	$2^6$	$2^5$	$2^4$	$2^3$	$2^2$	$2^1$	$2^0$
	bit7				bit0			

Voltage measurements of the MON3 input below this unsigned threshold will set its corresponding alarm bit. Measurements above this threshold will clear its alarm bit.

# Burst-Mode PON Controller With Integrated Monitoring

## Lower Memory Register 24h to 25h: MON3 Warn Hi

FACTORY DEFAULT: FFFFh

READ ACCESS All

WRITE ACCESS PW2

MEMORY TYPE: Nonvolatile (SEE)

24h	$2^{15}$	$2^{14}$	$2^{13}$	$2^{12}$	$2^{11}$	$2^{10}$	$2^9$	$2^8$	
25h	$2^7$	$2^6$	$2^5$	$2^4$	$2^3$	$2^2$	$2^1$	$2^0$	
	bit7								bit0

Voltage measurements of the MON3 input above this unsigned threshold will set its corresponding warning bit. Measurements below this threshold will clear its warning bit.

## Lower Memory Register 26h to 27h: MON3 Warn Lo

FACTORY DEFAULT: 0000h

READ ACCESS All

WRITE ACCESS PW2

MEMORY TYPE: Nonvolatile (SEE)

26h	$2^{15}$	$2^{14}$	$2^{13}$	$2^{12}$	$2^{11}$	$2^{10}$	$2^9$	$2^8$	
27h	$2^7$	$2^6$	$2^5$	$2^4$	$2^3$	$2^2$	$2^1$	$2^0$	
	bit7								bit0

Voltage measurements of the MON3 input below this unsigned threshold will set its corresponding warning bit. Measurements above this threshold will clear its warning bit.

## Lower Memory Register 28h to 2Fh: Shadowed EEPROM

FACTORY DEFAULT: 00h

READ ACCESS All

WRITE ACCESS PW2

MEMORY TYPE: Nonvolatile (SEE)

28h-2Fh	SEE	SEE	SEE	SEE	SEE	SEE	SEE	SEE	
	bit7								bit0

Shadowed EEPROM memory (see details in Memory Map section). PW2 level access controlled ROM data for end user.

# Burst-Mode PON Controller With Integrated Monitoring

## Lower Memory Register 30h to 5Fh: PW2 EE

FACTORY DEFAULT: 00h  
 READ ACCESS All  
 WRITE ACCESS PW2  
 MEMORY TYPE: Nonvolatile (EE)

30h-5Fh	EE	EE	EE	EE	EE	EE	EE	EE
	bit7							bit0

Nonvolatile EEPROM memory. PW2 level access controlled ROM data for end user.

## Lower Memory Register 60h to 61h: Temp Value

POWER-ON VALUE 0000h  
 READ ACCESS All  
 WRITE ACCESS N/A  
 MEMORY TYPE: Volatile

60h	S	$2^6$	$2^5$	$2^4$	$2^3$	$2^2$	$2^1$	$2^0$
61h	$2^1$	$2^2$	$2^3$	$2^4$	$2^5$	$2^6$	$2^7$	$2^8$
	bit7							bit0

Signed 2's complement Direct-to-Temperature measurement.

## Lower Memory, Register 62h–63h: VCC Value

## Lower Memory, Register 64h–65h: MON1 Value

## Lower Memory, Register 66h–67h: MON2 Value

## Lower Memory, Register 68h–69h: MON3 Value

POWER-ON VALUE 0000h  
 READ ACCESS All  
 WRITE ACCESS N/A  
 MEMORY TYPE: Volatile

62h	$2^{15}$	$2^{14}$	$2^{13}$	$2^{12}$	$2^{11}$	$2^{10}$	$2^9$	$2^8$
63h	$2^7$	$2^6$	$2^5$	$2^4$	$2^3$	$2^2$	$2^1$	$2^0$
64h	$2^{15}$	$2^{14}$	$2^{13}$	$2^{12}$	$2^{11}$	$2^{10}$	$2^9$	$2^8$
65h	$2^7$	$2^6$	$2^5$	$2^4$	$2^3$	$2^2$	$2^1$	$2^0$
66h	$2^{15}$	$2^{14}$	$2^{13}$	$2^{12}$	$2^{11}$	$2^{10}$	$2^9$	$2^8$
67h	$2^7$	$2^6$	$2^5$	$2^4$	$2^3$	$2^2$	$2^1$	$2^0$
68h	$2^{15}$	$2^{14}$	$2^{13}$	$2^{12}$	$2^{11}$	$2^{10}$	$2^9$	$2^8$
69h	$2^7$	$2^6$	$2^5$	$2^4$	$2^3$	$2^2$	$2^1$	$2^0$
	bit7							bit0

Unsigned voltage measurement.

# Burst-Mode PON Controller With Integrated Monitoring

## Lower Memory, Register 6Ah to 6D: Reserved

POWER-ON VALUE	00h
READ ACCESS	All
WRITE ACCESS	N/A
MEMORY TYPE	

These registers are reserved. The value when read is 00h.

## Lower Memory, Register 6Eh: Status

POWER-ON VALUE	x000 0x0x b
READ ACCESS	All
WRITE ACCESS	See Below
MEMORY TYPE	Volatile

Write Access	N/A	All	N/A	All	All	N/A	N/A	N/A
--------------	-----	-----	-----	-----	-----	-----	-----	-----

6Eh	FETG STATUS	SOFT FETG	RESERVED	TX-F RESET	SOFT TX-D	TX-F STATUS	RESERVED	RDYB
	bit7						bit0	

bit7	<b>FETG STATUS:</b> Reflects the active state of FETG. 0 = Bias and modulation outputs are enabled. 1 = The FETG output is asserted to disable the bias and modulation outputs.
bit6	<b>SOFT FETG:</b> 0 = (Default) 1 = Force the bias and modulation outputs to their off states and asserts the FETG output.
bit5	Reserved (Default = 0)
bit4	<b>TX-F RESET:</b> 0 = Does not affect the TX-F output (Default). 1 = Resets the latch for the TX-F output. This bit is self clearing after the reset.
bit3	<b>SOFT TX-D:</b> This bit allows a software control that is identical to the TX-D pin. Please see section on TX-D for further information. It's value is wired OR'ed with the logic value on TX-D pin. 0 = Internal TX-D signal is equal to external TX-D pin. 1 = Internal TX-D signal is high.
bit2	<b>TX-F STATUS:</b> Reflects the active state of TX-F. 0 = TX-F pin is not active. 1 = TX-F pin is active.
bit1	<b>RESERVED</b> (Default = 0)
bit0	<b>RDYB:</b> Ready Bar. 0 = V <sub>CC</sub> is above POA. 1 = V <sub>CC</sub> is below POA or too low to communicate over the I <sup>2</sup> C bus.



# Burst-Mode PON Controller With Integrated Monitoring

## Lower Memory, Register 6Fh: Update

POWER-ON VALUE	00h
READ ACCESS	All
WRITE ACCESS	All + DS1863 Hardware
MEMORY TYPE	Volatile

6Fh	TEMP RDY	V <sub>CC</sub> RDY	MON1 RDY	MON2 RDY	MON3 RDY	RESERVED	RESERVED	RESERVED
	bit7							bit0

Status of completed conversions. At Power-On, these bits are cleared and will be set as each conversion is completed. These bits can be cleared so that a completion of a new conversion is verified.

bit7	<b>TEMP RDY:</b> 0 = Temperature conversion is not ready (Default). 1 = Temperature conversion is ready.
bit6	<b>V<sub>CC</sub> RDY:</b> 0 = V <sub>CC</sub> conversion is not ready (Default). 1 = V <sub>CC</sub> conversion is ready.
bit5	<b>MON1 RDY:</b> 0 = MON1 conversion is not ready (Default). 1 = MON1 conversion is ready.
bit4	<b>MON2 RDY:</b> 0 = MON2 conversion is not ready (Default). 1 = MON2 conversion is ready.
bit3	<b>MON3 RDY:</b> 0 = MON3 conversion is not ready (Default). 1 = MON3 conversion is ready.
bit2:0	<b>RESERVED</b>

# Burst-Mode PON Controller With Integrated Monitoring

## Lower Memory, Register 70h: Alarm<sub>3</sub>

POWER-ON VALUE	10h
READ ACCESS	All
WRITE ACCESS	N/A
MEMORY TYPE	Volatile

70h	TEMP HI	TEMP LO	V <sub>CC</sub> HI	V <sub>CC</sub> LO	MON1 HI	MON1 LO	MON2 HI	MON2 LO
	bit7				bit0			

### Alarm Status Bits

bit7	<p><b>TEMP HI:</b> High Alarm Status for Temperature measurement. 0 = (Default) Last measurement was equal to or below threshold setting. 1 = Last measurement was above threshold setting.</p>
bit6	<p><b>TEMP LO:</b> Low Alarm Status for Temperature measurement. 0 = (Default) Last measurement was equal to or above threshold setting. 1 = Last measurement was below threshold setting.</p>
bit5	<p><b>V<sub>CC</sub> HI:</b> High Alarm Status for V<sub>CC</sub> measurement. 0 = (Default) Last measurement was equal to or below threshold setting. 1 = Last measurement was above threshold setting.</p>
bit4	<p><b>V<sub>CC</sub> LO:</b> Low Alarm Status for V<sub>CC</sub> measurement. This bit is set when the V<sub>CC</sub> supply is below the POA trip point value. It will clear itself when a V<sub>CC</sub> measurement is completed and the value is above the low threshold. 0 = Last measurement was equal to or above threshold setting. 1 = (Default) Last measurement was below threshold setting.</p>
bit3	<p><b>MON1 HI:</b> High Alarm Status for MON1 measurement. 0 = (Default) Last measurement was equal to or below threshold setting. 1 = Last measurement was above threshold setting.</p>
bit2	<p><b>MON1 LO:</b> Low Alarm Status for MON1 measurement. 0 = (Default) Last measurement was equal to or above threshold setting. 1 = Last measurement was below threshold setting.</p>
bit1	<p><b>MON2 HI:</b> High Alarm Status for MON2 measurement. 0 = (Default) Last measurement was equal to or below threshold setting. 1 = Last measurement was above threshold setting.</p>
bit0	<p><b>MON2 LO:</b> Low Alarm Status for MON2 measurement. 0 = (Default) Last measurement was equal to or above threshold setting. 1 = Last measurement was below threshold setting.</p>

# Burst-Mode PON Controller With Integrated Monitoring

## Lower Memory, Register 71h: Alarm<sub>2</sub>

POWER-ON VALUE            00h  
 READ ACCESS                All  
 WRITE ACCESS               N/A  
 MEMORY TYPE                Volatile

71h	MON3 HI	MON3 LO	RESERVED	RESERVED	RESERVED	RESERVED	RESERVED	RESERVED	RESERVED
	bit7								bit0

### Alarm Status Bits

bit7	<b>MON3 HI:</b> High Alarm Status for MON3 measurement. 0 = (Default) Last measurement was equal to or below threshold setting. 1 = Last measurement was above threshold setting.
bit6	<b>MON3 LO:</b> Low Alarm Status for MON3 measurement. 0 = (Default) Last measurement was equal to or above threshold setting. 1 = Last measurement was below threshold setting.
bit5:0	<b>RESERVED</b>

# Burst-Mode PON Controller With Integrated Monitoring

## Lower Memory, Register 72h: Alarm<sub>1</sub>

POWER-ON VALUE	00h
READ ACCESS	All
WRITE ACCESS	N/A
MEMORY TYPE	Volatile

72h	RESERVED	RESERVED	RESERVED	RESERVED	BIAS HI	RESERVED	TX-P HI	TX-P LO
	bit7							bit0

Alarm Status Bits

bit7:4	<b>RESERVED</b>
bit3	<b>BIAS HI:</b> High Alarm Status Bias; Fast Comparison. 0 = (Default) Last measurement was equal to or below threshold setting. 1 = Last measurement was above threshold setting.
bit2	<b>RESERVED</b>
bit1	<b>TX-P HI:</b> High Alarm Status TX-P; Fast Comparison. 0 = (Default) Last measurement was equal to or below threshold setting. 1 = Last measurement was above threshold setting.
bit0	<b>TX-P LO:</b> Low Alarm Status TX-P; Fast Comparison. 0 = Last measurement was equal to or above threshold setting. 1 = Last measurement was below threshold setting.

## Lower Memory, Register 73h: Alarm<sub>0</sub>

POWER-ON VALUE	00h
READ ACCESS	All
WRITE ACCESS	N/A
MEMORY TYPE	Volatile

73h	RESERVED	RESERVED	RESERVED	RESERVED	BIAS MAX	RESERVED	RESERVED	RESERVED
	bit7							bit0

Alarm Status Bits

bit7:4	<b>RESERVED</b>
bit3	<b>BIAS MAX:</b> Maximum digital setting for IBIAS. 0 = (Default) The value of IBIAS is equal to or below MAX IBIAS setting. 1 = Requested value of IBIAS is greater than MAX IBIAS setting.
bit2:0	<b>RESERVED</b>

# Burst-Mode PON Controller With Integrated Monitoring

## Lower Memory, Register 74h: Warn3

POWER-ON VALUE	10h
READ ACCESS	All
WRITE ACCESS	N/A
MEMORY TYPE	Volatile

74h	TEMP HI	TEMP LO	V <sub>CC</sub> HI	V <sub>CC</sub> LO	MON1 HI	MON1 LO	MON2 HI	MON2 LO
	bit7				bit0			

### Warning Status Bits

bit7	<b>TEMP HI:</b> High Warning Status for Temperature measurement. 0 = (Default) Last measurement was equal to or below threshold setting. 1 = Last measurement was above threshold setting.
bit6	<b>TEMP LO:</b> Low Warning Status for Temperature measurement. 0 = (Default) Last measurement was equal to or above threshold setting. 1 = Last measurement was below threshold setting.
bit5	<b>V<sub>CC</sub> HI:</b> High Warning Status for V <sub>CC</sub> measurement. 0 = (Default) Last measurement was equal to or below threshold setting. 1 = Last measurement was above threshold setting.
bit4	<b>V<sub>CC</sub> LO:</b> Low Warning Status for V <sub>CC</sub> measurement. This bit is set when the V <sub>CC</sub> supply is below the POA trip point value. It will clear itself when a V <sub>CC</sub> measurement is completed and the value is above the low threshold. 0 = Last measurement was equal to or above threshold setting. 1 = (Default) Last measurement was below threshold setting.
bit3	<b>MON1 HI:</b> High Warning Status for MON1 measurement. 0 = (Default) Last measurement was equal to or below threshold setting. 1 = Last measurement was above threshold setting.
bit2	<b>MON1 LO:</b> Low Warning Status for MON1 measurement. 0 = (Default) Last measurement was equal to or above threshold setting. 1 = Last measurement was below threshold setting.
bit1	<b>MON2 HI:</b> High Warning Status for MON2 measurement. 0 = (Default) Last measurement was equal to or below threshold setting. 1 = Last measurement was above threshold setting.
bit0	<b>MON2 LO:</b> Low Warning Status for MON2 measurement. 0 = (Default) Last measurement was equal to or above threshold setting. 1 = Last measurement was below threshold setting.

# Burst-Mode PON Controller With Integrated Monitoring

## Lower Memory, Register 75h: Warn<sub>2</sub>

POWER-ON VALUE	10h
READ ACCESS	All
WRITE ACCESS	N/A
MEMORY TYPE	Volatile

75h	MON3 HI	MON3 LO	RESERVED	RESERVED	RESERVED	RESERVED	RESERVED	RESERVED	RESERVED
	bit7							bit0	

### Warning Status Bits

bit7	<b>MON3 HI:</b> High Warning Status for Mon3 measurement. 0 = (Default) Last measurement was equal to or below threshold setting. 1 = Last measurement was above threshold setting.
bit6	<b>MON3 LO:</b> Low Warning Status for Mon3 measurement. 0 = (Default) Last measurement was equal to or above threshold setting. 1 = Last measurement was below threshold setting.
bit5	<b>RESERVED</b>

## Lower Memory, Register 76h to 7Ah: Reserved

POWER-ON VALUE	00h
READ ACCESS	All
WRITE ACCESS	N/A
MEMORY TYPE	

These registers are reserved. The value when read is 00h.

## Lower Memory, Register 7Bh to 7Eh: Password Entry (PWE)

FACTORY DEFAULT	FFFF FFFFh
READ ACCESS	N/A
WRITE ACCESS	All
MEMORY TYPE	Volatile

7Bh	2 <sup>31</sup>	2 <sup>30</sup>	2 <sup>29</sup>	2 <sup>28</sup>	2 <sup>27</sup>	2 <sup>26</sup>	2 <sup>25</sup>	2 <sup>24</sup>	
7Ch	2 <sup>23</sup>	2 <sup>22</sup>	2 <sup>21</sup>	2 <sup>20</sup>	2 <sup>19</sup>	2 <sup>18</sup>	2 <sup>17</sup>	2 <sup>16</sup>	
7Dh	2 <sup>15</sup>	2 <sup>14</sup>	2 <sup>13</sup>	2 <sup>12</sup>	2 <sup>11</sup>	2 <sup>10</sup>	2 <sup>9</sup>	2 <sup>8</sup>	
7Eh	2 <sup>7</sup>	2 <sup>6</sup>	2 <sup>5</sup>	2 <sup>4</sup>	2 <sup>3</sup>	2 <sup>2</sup>	2 <sup>1</sup>	2 <sup>0</sup>	
	bit7							bit0	

Password Entry. There are two passwords for the DS1863. Each password is 4 bytes long. The lower level password (PW1) will have all the access of a normal user plus those made available with PW1. The higher level password (PW2) will have all of the access of PW1 plus those made available with PW2. The values of the passwords reside in EE inside of PW2 memory. At Power up all PWE bits are set to 1. All reads to this location are 0.

# Burst-Mode PON Controller With Integrated Monitoring

DS1863

## Lower Memory Register 7Fh: Table Select (TBL SEL)

POWER-ON VALUE            00h  
READ ACCESS                All  
WRITE ACCESS               All  
MEMORY TYPE                Volatile

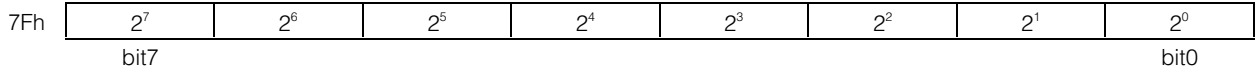

The upper memory tables (Table 01h–Table 05h) of the DS1863 are accessible by writing the correct table value in this register.

# Burst-Mode PON Controller With Integrated Monitoring

## Table 01h, Registers

**Table 01h, Register 80h to F7h: PW1 EEPROM**

POWER-ON VALUE	00h
READ ACCESS	PW1
WRITE ACCESS	PW1
MEMORY TYPE	Nonvolatile(EE)

80h-F7h	EE	EE	EE	EE	EE	EE	EE	EE
	bit7							bit0

EEPROM for PW1 level access.

**Table 01h, Register F8h: Alarm<sub>3</sub>**

POWER-ON VALUE	00h
READ ACCESS	All
WRITE ACCESS	PW1
MEMORY TYPE	Volatile

F8h	TEMP HI	TEMP LO	V <sub>CC</sub> HI	V <sub>CC</sub> LO	MON1 HI	MON1 LO	MON2 HI	MON2 LO
	bit7							bit0

Layout is identical to Alarm<sub>3</sub> in Lower Memory Register 70h with two exceptions.

1. V<sub>CC</sub> Low alarm is not set at power-on.
2. These bits are latched. They are cleared by power-down or a write with PW1 access.

**Table 01h, Register F9h: Alarm<sub>2</sub>**

POWER-ON VALUE	00h
READ ACCESS	All
WRITE ACCESS	PW1
MEMORY TYPE	Volatile

F9h	MON3 HI	MON3 LO	RESERVED	RESERVED	RESERVED	RESERVED	RESERVED	RESERVED
	bit7							bit0

Layout is identical to Alarm<sub>2</sub> in Lower Memory Register 71h with one exception.

1. These bits are latched. They are cleared by power-down or a write with PW1 access.



# Burst-Mode PON Controller With Integrated Monitoring

**Table 01h, Register FAh: Alarm<sub>1</sub>**

POWER-ON VALUE	00h
READ ACCESS	All
WRITE ACCESS	PW1
MEMORY TYPE	Volatile

FAh	BIAS HI	TX-P HI	TX-P LO	RESERVED	RESERVED	RESERVED	RESERVED	RESERVED	
	bit7								bit0

Layout is identical to Alarm<sub>1</sub> in Lower Memory Register 72h with one exception.

- These bits are latched. They are cleared by power-down or a write with PW1 access.

**Table 01h, Register FBh: Alarm<sub>0</sub>**

POWER-ON VALUE	00h
READ ACCESS	All
WRITE ACCESS	PW1
MEMORY TYPE	Volatile

72h	RESERVED	RESERVED	RESERVED	RESERVED	BIAS MAX	RESERVED	RESERVED	RESERVED	
	bit7								bit0

Layout is identical to Alarm<sub>0</sub> in Lower Memory Register 73h with one exception.

- These bits are latched. They are cleared by power-down or a write with PW1 access

**Table 01h, Register FCh: Warn<sub>3</sub>**

POWER-ON VALUE	00h
READ ACCESS	All
WRITE ACCESS	PW1
MEMORY TYPE	Volatile

FCh	TEMP HI	TEMP LO	V <sub>CC</sub> HI	V <sub>CC</sub> LO	MON1 HI	MON1 LO	MON2 HI	MON2 LO	
	bit7								bit0

Layout is identical to Warn<sub>3</sub> in Lower Memory Register 74h with two exceptions.

- V<sub>CC</sub> Low Warning is not set at power-on.
- These bits are latched. They are cleared by power-down or a write with PW1 access.

# Burst-Mode PON Controller With Integrated Monitoring

**Table 01h, Register FDh: Warn<sub>2</sub>**

POWER-ON VALUE	00h
READ ACCESS	All
WRITE ACCESS	PW1
MEMORY TYPE	Volatile

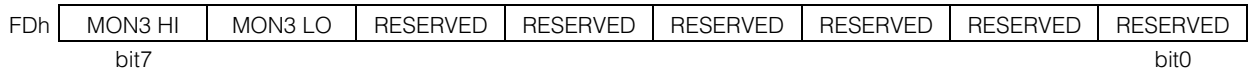

Layout is identical to Warn<sub>2</sub> in Lower Memory Register 75h with one exception.

1. These bits are latched. They are cleared by power-down or a write with PW1 access.

**Table 01h, Register FEh to FFh: Reserved**

POWER-ON VALUE	00h
READ ACCESS	All
WRITE ACCESS	PW1
MEMORY TYPE	Volatile

These registers are reserved.

# Burst-Mode PON Controller With Integrated Monitoring

## Table 02h, Registers

**Table 02h, Register 80h: Mode**

POWER-ON VALUE	0Fh
READ ACCESS	PW2
WRITE ACCESS	PW2
MEMORY TYPE	Volatile

80h	SEEB	RESERVED	RESERVED	RESERVED	AEN	MOD-EN	APC-EN	BIAS-EN
	bit7				bit0			

bit7	<p><b>SEEB:</b> 0 = Enables EEPROM writes to SEE bytes in Table 02h (Default). 1 = Disables EEPROM writes to SEE bytes during configuration, so that the configuration of the part is not delayed by the EE cycle time. Once the values are known, write this bit to a 0 and write the SEE locations again for data to be written to the EEPROM.</p>
bit6:4	<p><b>RESERVED</b></p>
bit3	<p><b>AEN:</b> 0 = The temperature calculated index value ('T Index') is write-able by the user and the updates of calculated indexes are disabled. This allows the user to interactively test their modules by controlling the indexing for the look-up tables. The recalled values from the LUTs will appear in the DAC registers after the next completion of a temperature conversion (just like it would happen in auto mode). Both DACs will update at the same time (just like auto mode). 1 = Enables auto control of the LUT (Default).</p>
bit2	<p><b>MOD-EN:</b> 0 = "MOD DAC" is write-able by the user and the LUT recalls are disabled. This allows the user to interactively test their modules by writing the DAC value for modulation. The output is updated with the new value at the end of the write cycle. The I_C Stop condition is the end of the write cycle. 1 = Enables auto control of the LUT for modulation (Default).</p>
bit1	<p><b>APC-EN:</b> 0 = "APC DAC" is write-able by the user and the LUT recalls are disabled. This allows the user to interactively test their modules by writing the DAC value for APC reference. The output is updated with the new value at the end of the write cycle. The I_C Stop condition is the end of the write cycle. 1 = Enables auto control of the LUT for APC reference (Default).</p>
bit0	<p><b>BIAS-EN:</b> 0 = "BIAS DAC" is controlled by the user and the APC is open loop. The "BIAS DAC" value is written to the "MAN IBIAS" Register. All values that are written to "MAN IBIAS" and are greater than the "MAX IBIAS" register setting are not updated and will set the "BIAS MAX" alarm bit. The "BIAS DAC" register will continue to reflect the value of the Bias DAC. This allows the user to interactively test their modules by writing the DAC value for bias. The output is updated with the new value at the end of the write cycle to the "MAN IBIAS" register. The I<sup>2</sup>C Stop condition is the end of the write cycle. 1 = Enables auto control for the APC feedback (Default).</p>

# Burst-Mode PON Controller With Integrated Monitoring

**Table 02h, Register 81h: Tindex**

POWER-ON VALUE            00h  
 READ ACCESS                PW2  
 WRITE ACCESS              PW2 and (AEN = 0)  
 MEMORY TYPE                Volatile

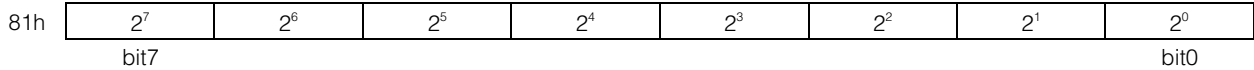

$$Tindex = \frac{Temperature + 40^{\circ}C}{2^{\circ}C} + 80h$$

Holds the calculated index based on the Temperature Measurement. This index is used for the address during Look-Up of Tables 04h and 05h.

For Table 04h, the exact address as the value of Tindex is used. For Table 05h the address used is calculated as follows

$$\frac{Tindex - 80h}{2} + 80h$$

**Table 02h, Register 82h: MOD DAC**

POWER-ON VALUE            00h  
 READ ACCESS                PW2  
 WRITE ACCESS              PW2 and (MOD-EN = 0)  
 MEMORY TYPE                Volatile

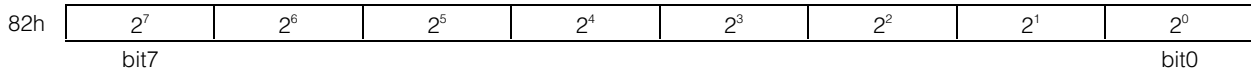

The digital value used for MOD and recalled from Table 04h at the adjusted memory address found in Tindex. The address used is calculated as follows

$$Tindex = \frac{TEMP + 40h}{2}$$

This register is updated at the end of the Temperature conversion.

**Table 02h, Register 83h: APC DAC**

POWER-ON VALUE            00h  
 READ ACCESS                PW2  
 WRITE ACCESS              PW2 and (APC-EN = 0)  
 MEMORY TYPE                Volatile

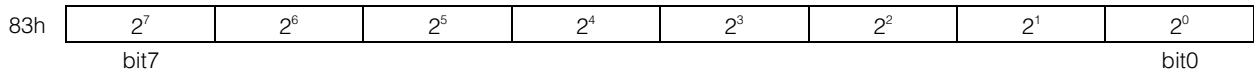

The digital value used for APC reference and recalled from Table 05h at the memory address found in 'T Index'. This register is updated at the end of the Temperature conversion.

# Burst-Mode PON Controller With Integrated Monitoring

**Table 02h, Register 84h to 85h: BIAS DAC**

FACTORY DEFAULT            00 00h  
 READ ACCESS                PW2  
 WRITE ACCESS               PW2 and (BIAS-EN = 0)  
 MEMORY TYPE                Volatile

84h	0	0	$2^{12}$	$2^{11}$	$2^{10}$	$2^9$	$2^8$	$2^7$
85h	$2^7$	$2^6$	$2^5$	$2^4$	$2^3$	$2^2$	$2^1$	$2^0$
	bit7							bit0

The digital value used for IBIAS.

**Table 02h, Register 86h: Device ID**

FACTORY DEFAULT            63h  
 READ ACCESS                PW2  
 WRITE ACCESS               N/A  
 MEMORY TYPE                ROM

86h	0	1	1	0	0	0	1	1
	bit7							bit0

Hard wired to show device ID.

**Table 02h, Register 87h: Device VER**

FACTORY DEFAULT            Device Version  
 READ ACCESS                PW2  
 WRITE ACCESS               N/A  
 MEMORY TYPE                ROM

87h	DEVICE VERSION							
	bit7							bit0

Hard wired connections to show Device Version.

# Burst-Mode PON Controller With Integrated Monitoring

**Table 02h, Register 88h: Update Rate**

FACTORY DEFAULT            00h  
 READ ACCESS                PW2  
 WRITE ACCESS               PW2  
 MEMORY TYPE                Nonvolatile (SEE)  
 Defines the update rate for comparison of APC control.

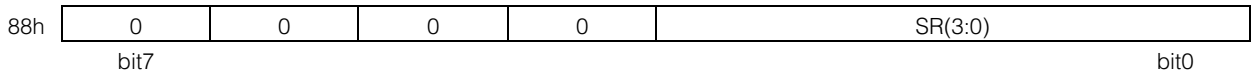

bit7:4	0
bit3:0	<b>SR(3:0)</b> : 4-bit update rate for comparison of APC control.

SR <sub>3</sub> -SR <sub>0</sub>	MINIMUM TIME FROM BEN TO FIRST SAMPLE (t <sub>FIRST</sub> ) ±50ns	REPEATED SAMPLE PERIOD FOLLOWING FIRST SAMPLE (t <sub>REP</sub> )
0000b	350ns	800ns
0001b	550ns	1200ns
0010b	750ns	1600ns
0011b	950ns	2000ns
0100b	1350ns	2800ns
0101b	1550ns	3200ns
0110b	1750ns	3600ns
0111b	2150ns	4400ns
1000b	2950ns	6000ns
1001b*	3150ns	6400ns

*\*All codes greater than 1001b (1010b-111b) use the maximum sample time of code 1001b.*

# Burst-Mode PON Controller With Integrated Monitoring

**Table 02h, Register 89h: Config**

FACTORY DEFAULT	00h
READ ACCESS	PW2
WRITE ACCESS	PW2
MEMORY TYPE	Nonvolatile (SEE)

89h	FETG DIR	TX-F EN	RESERVED	ASEL	RESERVED	RESERVED	RESERVED	RESERVED
	bit7				bit0			

Configure the memory location and the polarity of the digital outputs.

bit7	<p><b>FETG DIR:</b> Chooses the direction or polarity of the FETG output for normal operation. 0 = Under normal operation, FETG will be pulled low. (Default) 1 = Under normal operation, FETG will be pulled high.</p>
bit6	<p><b>TX-F EN:</b> 0 = The alarm bits will immediately reflect the status of the last comparison. (Default) 1 = The alarm bits are latched until cleared by a TX-D transition or Power-down. If V<sub>CC</sub> low alarm is enabled for either FETG or TX-F then latching is disabled until after the first V<sub>CC</sub> measurement is made above the V<sub>CC</sub> to set-point to allow for proper operation during slow power-on cycles.</p>
bit5	<b>RESERVED</b>
bit4	<p><b>ASEL:</b> Address SElect. 0 = Device Address of A2h (Default). 1 = Device-Address is equal to the value found in byte 'device_address' (Table 02h, 8Ch).</p>
bit3:0	<b>RESERVED</b>

**Table 02h, Register 8Ah: Startup Step**

FACTORY DEFAULT:	00h
READ ACCESS	PW2
WRITE ACCESS	PW2
MEMORY TYPE:	Nonvolatile (SEE)

8Ah	2 <sup>12</sup>	2 <sup>11</sup>	2 <sup>10</sup>	2 <sup>9</sup>	2 <sup>8</sup>	2 <sup>7</sup>	2 <sup>6</sup>	2 <sup>5</sup>
	bit7				bit0			

This value will define the maximum allowed step for the upper 8 bits of IBIAS output during start-up.

# Burst-Mode PON Controller With Integrated Monitoring

**Table 02h, Register 8Bh: MOD Ranging**

FACTORY DEFAULT: 00h  
 READ ACCESS PW2  
 WRITE ACCESS PW2  
 MEMORY TYPE: Nonvolatile (SEE)

8Bh	RESERVED	RESERVED	RESERVED	RESERVED	RESERVED	MOD <sub>2</sub>	MOD <sub>1</sub>	MOD <sub>0</sub>
	bit7					bit0		

The lower nibble of this byte controls the Full-Scale range of the Modulation DAC

bit7:3	<b>RESERVED</b> (Default = 0)
bit2:0	<b>MOD RANGING:</b> 3-bit value to select FS output voltage for V <sub>MOD</sub> . Default 0006 and creates a FS of 1.25V.

MOD <sub>2</sub> TO MOD <sub>0</sub>	% OF 1.25V	FS VOLTAGE
000b	100	1.250
001b	80.05	1.001
010b	66.75	0.833
011b	50.13	0.627
100b	40.16	0.502
101b	33.5	0.419
110b	28.75	0.359
111b	25.18	0.315

**Table 02h, Register 8Ch: Device Address**

FACTORY DEFAULT: 00h  
 READ ACCESS PW2  
 WRITE ACCESS PW2  
 MEMORY TYPE: Nonvolatile (SEE)

8Ch	2 <sup>7</sup>	2 <sup>6</sup>	2 <sup>5</sup>	2 <sup>4</sup>	2 <sup>3</sup>	2 <sup>2</sup>	2 <sup>1</sup>	X
	bit7							bit0

X = Don't care.

This value becomes the Device address for the main memory when *ASEL* (Table 02h, 89h) bit is set.



# Burst-Mode PON Controller With Integrated Monitoring

**Table 02h, Register 8Dh: Comp Ranging**

FACTORY DEFAULT: 00h  
 READ ACCESS PW2  
 WRITE ACCESS PW2  
 MEMORY TYPE: Nonvolatile (SEE)

8Dh	RESERVED	RESERVED	RESERVED	RESERVED	RESERVED	APC <sub>2</sub>	APC <sub>1</sub>	APC <sub>0</sub>
	bit7					bit0		

This byte controls the Full-Scale range for the Quick-Trip monitoring of the APC reference as well as the closed loop monitoring of APC.

bit7:3	<b>RESERVED</b> (Default = 0)
bit2:0	<b>APC RANGING:</b> 3-bit value to select the FS comparison voltage for BMD with the APC. Default is 000b and creates a FS voltage of 2.5V.

APC <sub>2</sub> TO APC <sub>0</sub>	% OF 2.5V	FS VOLTAGE
000b	100	2.500
001b	80.07	2.002
010b	66.79	1.670
011b	50.18	1.255
100b	40.22	1.006
101b	33.57	0.839
110b	28.82	0.721
111b	25.26	0.632

**Table 02h, Register 8Eh: Right Shift<sub>1</sub>**

FACTORY DEFAULT: 00h  
 READ ACCESS PW2  
 WRITE ACCESS PW2  
 MEMORY TYPE: Nonvolatile (SEE)

8Eh	RESERVED	MON1_2	MON1_1	MON1_0	RESERVED	MON2_2	MON2_1	MON2_0
	bit7				bit0			

Allows for right-shifting the final answer of MON1 and MON2 voltage measurements. This allows for scaling the measurements to the smallest Full-scale voltage and then right-shifting the final result so the reading is weighted to the correct LSB.

# Burst-Mode PON Controller With Integrated Monitoring

**Table 02h, Register 8Fh: Right Shift<sub>0</sub>**

FACTORY DEFAULT: 00h  
 READ ACCESS PW2  
 WRITE ACCESS PW2  
 MEMORY TYPE: Nonvolatile (SEE)

8Fh	RESERVED	MON3_2	MON3_1	MON3_0	RESERVED	RESERVED	RESERVED	RESERVED
	bit7				bit0			

Allows for right-shifting the final answer of MON3 voltage measurements. This allows for scaling the measurements to the smallest full-scale voltage and then right-shifting the final result so the reading is weighted to the correct LSB.

**Table 02h, Register 90h to 91h: Reserved**

FACTORY DEFAULT: 0000h  
 READ ACCESS PW2  
 WRITE ACCESS PW2  
 MEMORY TYPE: Nonvolatile (SEE)

These registers are reserved.

**Table 02h, Register 92h to 93h: V<sub>CC</sub> Scale**

FACTORY CALIBRATED  
 READ ACCESS PW2  
 WRITE ACCESS PW2  
 MEMORY TYPE Nonvolatile (SEE)

92h	2 <sup>15</sup>	2 <sup>14</sup>	2 <sup>13</sup>	2 <sup>12</sup>	2 <sup>11</sup>	2 <sup>10</sup>	2 <sup>9</sup>	2 <sup>8</sup>
93h	2 <sup>7</sup>	2 <sup>6</sup>	2 <sup>5</sup>	2 <sup>4</sup>	2 <sup>3</sup>	2 <sup>2</sup>	2 <sup>1</sup>	2 <sup>0</sup>
	bit7				bit0			

Controls the Scaling or Gain of the V<sub>CC</sub> measurements. The factory-calibrated value will produce a FS voltage of 6.5536V.

# Burst-Mode PON Controller With Integrated Monitoring

**Table 02h, Register 94h to 95h: MON1 Scale**

**Table 02h, Register 96h to 97h: MON2 Scale**

**Table 02h, Register 98h to 99h: MON3 Scale**

FACTORY CALIBRATED

READ ACCESS PW2

WRITE ACCESS PW2

MEMORY TYPE Nonvolatile (SEE)

94h	$2^{15}$	$2^{14}$	$2^{13}$	$2^{12}$	$2^{11}$	$2^{10}$	$2^9$	$2^8$
95h	$2^7$	$2^6$	$2^5$	$2^4$	$2^3$	$2^2$	$2^1$	$2^0$
96h	$2^{15}$	$2^{14}$	$2^{13}$	$2^{12}$	$2^{11}$	$2^{10}$	$2^9$	$2^8$
97h	$2^7$	$2^6$	$2^5$	$2^4$	$2^3$	$2^2$	$2^1$	$2^0$
98h	$2^{15}$	$2^{14}$	$2^{13}$	$2^{12}$	$2^{11}$	$2^{10}$	$2^9$	$2^8$
99h	$2^7$	$2^6$	$2^5$	$2^4$	$2^3$	$2^2$	$2^1$	$2^0$

bit7

bit0

Controls the Scaling or Gain of the MON1, MON2, and MON3 measurements. The default hexadecimal value will correspond to 2.5V. The factory-calibrated value will produce a FS voltage of 2.5V.

**Table 02h, Register 9Ah to A1h: Reserved**

FACTORY DEFAULT 0000h

READ ACCESS PW2

WRITE ACCESS PW2

MEMORY TYPE Nonvolatile (SEE)

These registers are reserved.

**Table 02h, Register A2h to A3h: V<sub>CC</sub> Offset**

FACTORY DEFAULT 0000h

READ ACCESS PW2

WRITE ACCESS PW2

MEMORY TYPE Nonvolatile (SEE)

A2h	S	S	$2^{15}$	$2^{14}$	$2^{13}$	$2^{12}$	$2^{11}$	$2^{10}$
A3h	$2^9$	$2^8$	$2^7$	$2^6$	$2^5$	$2^4$	$2^3$	$2^2$

bit7

bit0

Allows for offset control of V<sub>CC</sub> measurement if desired.

# Burst-Mode PON Controller With Integrated Monitoring

**Table 02h, Register A4h to A5h: MON1 Offset**

**Table 02h, Register A6h to A7h: MON2 Offset**

**Table 02h, Register A8h to A9h: MON3 Offset**

FACTORY DEFAULT            0000h  
 READ ACCESS                PW2  
 WRITE ACCESS               PW2  
 MEMORY TYPE                Nonvolatile (SEE)

A4h	S	S	$2^{15}$	$2^{14}$	$2^{13}$	$2^{12}$	$2^{11}$	$2^{10}$
A5h	$2^9$	$2^8$	$2^7$	$2^6$	$2^5$	$2^4$	$2^3$	$2^2$
A6h	S	S	$2^{15}$	$2^{14}$	$2^{13}$	$2^{12}$	$2^{11}$	$2^{10}$
A7h	$2^9$	$2^8$	$2^7$	$2^6$	$2^5$	$2^4$	$2^3$	$2^2$
A8h	S	S	$2^{15}$	$2^{14}$	$2^{13}$	$2^{12}$	$2^{11}$	$2^{10}$
A9h	$2^9$	$2^8$	$2^7$	$2^6$	$2^5$	$2^4$	$2^3$	$2^2$

bit7 bit0

Allows for offset control of MON1, MON2, and MON3 measurement if desired.

**Table 02h, Register AAh to ADh: Reserved**

FACTORY DEFAULT            0000 0000h  
 READ ACCESS                PW2  
 WRITE ACCESS               PW2  
 MEMORY TYPE                Nonvolatile (SEE)

These registers are reserved.

**Table 02h, Register AEh to AFh: Temp Offset**

FACTORY CALIBRATED  
 READ ACCESS                PW2  
 WRITE ACCESS               PW2  
 MEMORY TYPE                Nonvolatile (SEE)

AEh	S	$2^8$	$2^7$	$2^6$	$2^5$	$2^4$	$2^3$	$2^2$
AFh	$2^1$	$2^0$	$2^{-1}$	$2^{-2}$	$2^{-3}$	$2^{-4}$	$2^{-5}$	$2^{-6}$

bit7 bit0

Allows for offset control of Temp measurement if desired. The Final Result must be XOR'ed with BB40h before writing to this register. Factory calibration contains the desired value for a reading of the temperature in degrees celcius.

# Burst-Mode PON Controller With Integrated Monitoring

**Table 02h, Register B0h to B3h: PW1**

FACTORY DEFAULT	FFFF FFFFh
READ ACCESS	N/A
WRITE ACCESS	PW2
MEMORY TYPE	Nonvolatile (SEE)

B0h	$2^{31}$	$2^{30}$	$2^{29}$	$2^{28}$	$2^{27}$	$2^{26}$	$2^{25}$	$2^{24}$
B1h	$2^{23}$	$2^{22}$	$2^{21}$	$2^{20}$	$2^{19}$	$2^{18}$	$2^{17}$	$2^{16}$
B2h	$2^{15}$	$2^{14}$	$2^{13}$	$2^{12}$	$2^{11}$	$2^{10}$	$2^9$	$2^8$
B3h	$2^7$	$2^6$	$2^5$	$2^4$	$2^3$	$2^2$	$2^1$	$2^0$
	bit7				bit0			

The PWE value is compared against the value written to this location to enable PW1 access. At power-on, the PWE value is set to all ones. Thus writing these bytes to all ones grants PW1 access on power-up without writing the password entry. All reads of this register are 00h.

**Table 02h, Register B4h to B7h: PW2**

FACTORY DEFAULT	FFFF FFFFh
READ ACCESS	N/A
WRITE ACCESS	PW2
MEMORY TYPE	Nonvolatile (SEE)

B4h	$2^{31}$	$2^{30}$	$2^{29}$	$2^{28}$	$2^{27}$	$2^{26}$	$2^{25}$	$2^{24}$
B5h	$2^{23}$	$2^{22}$	$2^{21}$	$2^{20}$	$2^{19}$	$2^{18}$	$2^{17}$	$2^{16}$
B6h	$2^{15}$	$2^{14}$	$2^{13}$	$2^{12}$	$2^{11}$	$2^{10}$	$2^9$	$2^8$
B7h	$2^7$	$2^6$	$2^5$	$2^4$	$2^3$	$2^2$	$2^1$	$2^0$
	bit7				bit0			

The PWE value is compared against the value written to this location to enable PW2 access. At power-on, the PWE value is set to all ones. Thus writing these bytes to all ones grants PW2 access on power-up without writing the password entry. All reads of this register are 00h.

# Burst-Mode PON Controller With Integrated Monitoring

**Table 02h, Register B8h: FETG Enable<sub>1</sub>**

FACTORY DEFAULT	00h
READ ACCESS	PW2
WRITE ACCESS	PW2
MEMORY TYPE	Nonvolatile (SEE)

B8h	TEMP EN	V <sub>CC</sub> EN	MON1 EN	MON2 EN	MON3 EN	RESERVED	RESERVED	RESERVED
	bit7							bit0

Configures the maskable interrupt for the FETG pin.

bit7	<b>TEMP EN:</b> Enables/Disables active interrupts on the FETG pin due to temperature measurements outside the threshold limits. 0 = Disable (Default) 1 = Enable
bit6	<b>V<sub>CC</sub> EN:</b> Enables/Disables active interrupts on the FETG pin due to V <sub>CC</sub> measurements outside the threshold limits. 0 = Disable (Default) 1 = Enable
bit5	<b>MON1 EN:</b> Enables/Disables active interrupts on the FETG pin due to MON1 measurements outside the threshold limits. 0 = Disable (Default) 1 = Enable
bit4	<b>MON2 EN:</b> Enables/Disables active interrupts on the FETG pin due to MON2 measurements outside the threshold limits. 0 = Disable (Default) 1 = Enable
bit3	<b>MON3 EN:</b> Enables/Disables active interrupts on the FETG pin due to MON3 measurements outside the threshold limits. 0 = Disable (Default) 1 = Enable
bit2:0	<b>RESERVED</b> (Default = 0)

# Burst-Mode PON Controller With Integrated Monitoring

**Table 02h, Register B9h: FETG Enable**

FACTORY DEFAULT	00h
READ ACCESS	PW2
WRITE ACCESS	PW2
MEMORY TYPE	Nonvolatile (SEE)

B9h	TXP-HI EN	TXP-LO EN	BIAS-HI EN	BIAS MAX EN	RESERVED	RESERVED	RESERVED	RESERVED
	bit7				bit0			

Configures the maskable interrupt for the FETG pin.

bit7	<p><b>TX-P-HI EN:</b> Enables/Disables active interrupts on the FETG pin due to Tx-P fast comparisons above the threshold limit. 0 = Disable (Default) 1 = Enable.</p>
bit6	<p><b>TX-P-LO EN:</b> Enables/Disables active interrupts on the FETG pin due to Tx-P fast comparisons below the threshold limit. 0 = Disable (Default) 1 = Enable</p>
bit5	<p><b>BIAS-HI EN:</b> Enables/Disables active interrupts on the FETG pin due to BIAS fast comparisons above the threshold limit. 0 = Disable (Default) 1 = Enable</p>
bit4	<p><b>BIAS MAX EN:</b> Enables/Disables active interrupts on the FETG pin due to BIAS fast comparisons below the threshold limit. 0 = Disable (Default) 1 = Enable</p>
bit3:0	<p><b>RESERVED</b> (Default = 0)</p>

# Burst-Mode PON Controller With Integrated Monitoring

**Table 02h, Register BAh: TX-F Enable<sub>1</sub>**

FACTORY DEFAULT	00h
READ ACCESS	PW2
WRITE ACCESS	PW2
MEMORY TYPE	Nonvolatile (SEE)

BAh	TEMP EN	V <sub>CC</sub> EN	MON1 EN	MON2 EN	MON3 EN	RESERVED	RESERVED	RESERVED
	bit7							bit0

Configures the maskable interrupt for the TX-F pin.

bit7	<p><b>TEMP EN:</b> Enables/Disables active interrupts on the TX-F pin due to temperature measurements outside the threshold limits. 0 = Disable (Default) 1 = Enable</p>
bit6	<p><b>V<sub>CC</sub> EN:</b> Enables/Disables active interrupts on the TX-F pin due to V<sub>CC</sub> measurements outside the threshold limits. 0 = Disable (Default) 1 = Enable</p>
bit5	<p><b>MON1 EN:</b> Enables/Disables active interrupts on the TX-F pin due to MON1 measurements outside the threshold limits. 0 = Disable (Default) 1 = Enable</p>
bit4	<p><b>MON2 EN:</b> Enables/Disables active interrupts on the TX-F pin due to MON2 measurements outside the threshold limits. 0 = Disable (Default) 1 = Enable.</p>
bit3	<p><b>MON3 EN:</b> Enables/Disables active interrupts on the TX-F pin due to MON3 measurements outside the threshold limits. 0 = Disable (Default) 1 = Enable</p>
bit2:0	<p><b>RESERVED</b> (Default = 0)</p>



# Burst-Mode PON Controller With Integrated Monitoring

**Table 02h, Register BBh: TX-F Enable<sub>0</sub>**

FACTORY DEFAULT	00h
READ ACCESS	PW2
WRITE ACCESS	PW2
MEMORY TYPE	Nonvolatile (SEE)

BBh	TXP-HI EN	TXP-LO EN	BIAS-HI EN	BIAS MAX EN	RESERVED	RESERVED	RESERVED	FETG EN
	bit7				bit0			

Configures the maskable interrupt for the Tx-F pin.

bit7	<p><b>TXP-HI EN:</b> Enables/Disables active interrupts on the Tx-F pin due to Tx-P fast comparisons above the threshold limit. 0 = Disable (Default) 1 = Enable.</p>
bit6	<p><b>TXP-LO EN:</b> Enables/Disables active interrupts on the Tx-F pin due to Tx-P fast comparisons below the threshold limit. 0 = Disable (Default) 1 = Enable</p>
bit5	<p><b>BIAS-HI EN:</b> Enables/Disables active interrupts on the Tx-F pin due to BIAS fast comparisons above the threshold limit. 0 = Disable (Default) 1 = Enable</p>
bit4	<p><b>BIAS MAX EN:</b> Enables/Disables active interrupts on the Tx-F pin due to BIAS fast comparisons above the threshold limit. 0 = Disable (Default) 1 = Enable</p>
bit3:1	<p><b>RESERVED</b> (Default = 0)</p>
bit0	<p><b>FETG EN:</b> 0 = Normal FETG operation (Default) 1 = Enables FETG to act as an input to Tx-F output.</p>

# Burst-Mode PON Controller With Integrated Monitoring

**Table 02h, Register BCh: HTXP**

FACTORY DEFAULT: 00h  
 READ ACCESS PW2  
 WRITE ACCESS PW2  
 MEMORY TYPE: Nonvolatile (SEE)

BCh	$2^7$	$2^6$	$2^5$	$2^4$	$2^3$	$2^2$	$2^1$	$2^0$
	bit7							bit0

Fast comparison DAC adjust for High TXP. This value is added to the APC\_DAC value recalled from Table 04h. If the sum is greater than 0xFF then 0xFF is used. Comparisons greater than APC\_DAC plus this value, found on the BMD pin, will create a TX-P HI alarm.

**Table 02h, Register BDh: LTXP**

FACTORY DEFAULT: 00h  
 READ ACCESS PW2  
 WRITE ACCESS PW2  
 MEMORY TYPE: Nonvolatile (SEE)

BDh	$2^7$	$2^6$	$2^5$	$2^4$	$2^3$	$2^2$	$2^1$	$2^0$
	bit7							bit0

Fast comparison DAC adjust for Low TXP. This value is subtracted from the APC\_DAC value recalled from Table 04h. If the difference is less than 0x00 then 0x00 is used. Comparisons less than APC\_DAC minus this value, found on the BMD pin, will create a TX-PLO alarm.

**Table 02h, Register BEh: HBIAS**

FACTORY DEFAULT: 00h  
 READ ACCESS PW2  
 WRITE ACCESS PW2  
 MEMORY TYPE: Nonvolatile (SEE)

BEh	$2^7$	$2^6$	$2^5$	$2^4$	$2^3$	$2^2$	$2^1$	$2^0$
	bit7							bit0

Fast comparison DAC setting for High BIAS.

# Burst-Mode PON Controller With Integrated Monitoring

**Table 02h, Register BFh: MAX IBIAS**

FACTORY DEFAULT: 00h  
 READ ACCESS PW2  
 WRITE ACCESS PW2  
 MEMORY TYPE: Nonvolatile (SEE)

BFh	2 <sup>12</sup>	2 <sup>11</sup>	2 <sup>10</sup>	2 <sup>9</sup>	2 <sup>8</sup>	2 <sup>7</sup>	2 <sup>6</sup>	2 <sup>5</sup>	
	bit7							bit0	

This value will define the maximum DAC value allowed for the upper 8 bits of IBIAS output during all operations. During the initial step and binary search, this value will not cause an alarm but will still clamp the IBIAS DAC output. After the startup sequence (or normal APC operations), if the APC loop tries to create an IBIAS value greater than this setting, IBIAS is clamped, and creates a BIAS MAX alarm. Settings 00h through FEh are intended for normal APC mode of operation. Setting FFh is reserved for manual IBIAS mode.

**Table 02h, Register C0h to F7h: Empty**

**Table 02h, Register F8h–F9h: MAN IBIAS**

FACTORY DEFAULT: 00h  
 READ ACCESS PW2  
 WRITE ACCESS PW2 and (BIAS-EN = 0)  
 MEMORY TYPE: Volatile

F8h	RESERVED	RESERVED	2 <sup>12</sup>	2 <sup>11</sup>	2 <sup>10</sup>	2 <sup>9</sup>	2 <sup>8</sup>	2 <sup>7</sup>	
F9h	2 <sup>7</sup>	2 <sup>6</sup>	2 <sup>5</sup>	2 <sup>4</sup>	2 <sup>3</sup>	2 <sup>2</sup>	2 <sup>1</sup>	2 <sup>0</sup>	
	bit7							bit0	

When “BIAS-EN” (Table 02h, 80h) is written to 0, writes to these bytes will control the lower portion of the IBIAS DAC [7:0].

**Table 02h, Register FAh: MAN\_CNTL**

FACTORY DEFAULT: 00h  
 READ ACCESS PW2  
 WRITE ACCESS PW2 and (BIAS-EN = 0)  
 MEMORY TYPE: Volatile

FAh	RESERVED	RESERVED	RESERVED	RESERVED	RESERVED	RESERVED	RESERVED	MAN_CLK	
	bit7							bit0	

When “BIAS-EN” bit (Table 02h, 80h) is written to zero, bit zero of this byte will control the updates of the MAN IBIAS value to the Bias output. The Values of MAN IBIAS should be written with a separate write command. Setting bit zero to a ‘1’ will clock the MAN IBIAS value to the output DAC.

1. Write the MAN IBIAS value with a write command.
2. Set the MAN CLK bit to a ‘1’ with a separate write command.
3. Clear the MAN CLK bit to a ‘0’ with a separate write command.

# Burst-Mode PON Controller With Integrated Monitoring

**Table 02h, Register FBh to FFh: Reserved**

FACTORY DEFAULT

READ ACCESS

WRITE ACCESS

MEMORY TYPE:

These registers are reserved.

**Table 03h, Register Descriptions**

**Table 03h, Register 80h to FFh: PW2 EEPROM**

FACTORY DEFAULT 00h

READ ACCESS PW2

WRITE ACCESS PW2

MEMORY TYPE: Nonvolatile (EE)

80h-FFh	EE	EE	EE	EE	EE	EE	EE	EE
	bit7							bit0

PW2 general-purpose EEPROM.

**Table 04h, Register Descriptions**

**Table 04h, Register 80h to C7h: Modulation LUT**

FACTORY DEFAULT 00h

READ ACCESS PW2

WRITE ACCESS PW2

MEMORY TYPE: Nonvolatile (EE)

80h-C7h	2 <sup>7</sup>	2 <sup>6</sup>	2 <sup>5</sup>	2 <sup>4</sup>	2 <sup>3</sup>	2 <sup>2</sup>	2 <sup>1</sup>	2 <sup>0</sup>
	bit7							bit0

The unsigned value for modulation DAC output.

The Modulation LUT is a set of registers assigned to hold the temperature profile for the Modulation DAC. The values in this table combined with the MOD bits in the MOD Ranging register (Table 02h, Register 8Bh) determine the set point for the Modulation Voltage. The temperature measurement is used to index the LUT (T INDEX, Table 02h, Register 81h) in 2°C increments from -40°C to +102°C, starting at 80h in Table 04h. Register 80h defines the -40°C to -38°C MOD output, register 81h defines -38°C to -36°C MOD output, and so on. Values recalled from this EEPROM memory table are written into the MOD DAC location which holds the value until the next temperature conversion. The part can be placed into a manual mode (Mod\_En bit, Table 02h, Register 80h), where MOD DAC can be directly controlled for calibration. If the temperature compensation functionality is not required, then program the entire Table 04h, to the desired modulation setting.

# Burst-Mode PON Controller With Integrated Monitoring

## Table 05h, Register Descriptions

**Table 05h, Register 80h to C7h: APC Tracking Error LUT**

FACTORY DEFAULT            00h  
 READ ACCESS                PW2  
 WRITE ACCESS              PW2  
 MEMORY TYPE:              Nonvolatile (EE)

80h-A3h	2 <sup>7</sup>	2 <sup>6</sup>	2 <sup>5</sup>	2 <sup>4</sup>	2 <sup>3</sup>	2 <sup>2</sup>	2 <sup>1</sup>	2 <sup>0</sup>	
	bit7							bit0	

The Tracking Error LUT is set of registers assigned to hold the temperature profile for the APC reference DAC. The values in this table combined with the APC bits in the Comp Ranging register (Table 02h, Register 8Dh) determine the set point for the APC loop. The on board temperature measurement is used to index the LUT (T INDEX, Table 02h, Register 81h) in 4°C increments from -40°C to +100°C, starting at register 80h in Table 05h. Register 80h defines the -40°C to -36°C APC reference value, register 81h defines -36°C to -32°C APC reference value, and so on. Values recalled from this EEPROM memory table are written into the APC DAC location, which holds the value until the next temperature conversion. The part can be placed into a manual mode (Apc\_En bit, Table 02h, Register 80h), where APC DAC can be directly controlled for calibration. If tracking error temperature compensation is not required by the application, program the entire LUT to the APC set-point.

**Table 05h, Register A3h to A7h: Reserved**

FACTORY DEFAULT  
 READ ACCESS  
 WRITE ACCESS  
 MEMORY TYPE:  
 These registers are reserved.

## Revision History

Pages changed at Rev 1: 1, 3, 4, 9, 13, 43, 44

## Package Information

For the latest package outline information, go to  
[www.maxim-ic.com/DallasPackInfo](http://www.maxim-ic.com/DallasPackInfo).

Maxim cannot assume responsibility for use of any circuitry other than circuitry entirely embodied in a Maxim product. No circuit patent licenses are implied. Maxim reserves the right to change the circuitry and specifications without notice at any time.

61 **Maxim Integrated Products, 120 San Gabriel Drive, Sunnyvale, CA 94086 408-737-7600**

© 2006 Maxim Integrated Products

**MAXIM** is a registered trademark of Maxim Integrated Products, Inc.

**DALLAS** SEMICONDUCTOR is a registered trademark of Dallas Semiconductor Corporation.